

Getting Started

Handset Parts	1-2	Mobile Manners	1-20
Basic Key Operations	1-3	Activating Manner Mode.....	1-20
Opening/Closing Handset.....	1-5	Codes	1-21
Touch Sensor	1-6	Security Code	1-21
Display	1-7	Center Access Code.....	1-21
Display Indicators	1-7	Network Password.....	1-21
Mobile Widget (Japanese).....	1-8	Other Basic Information	1-22
Key Illumination.....	1-8	Checking Battery Level.....	1-22
USIM Card	1-10	My Phone Number.....	1-22
Before Using USIM Card	1-10	Checking Network Status.....	1-22
Other Notes on USIM Cards.....	1-10	Stereo Earphone Conversion Cable	1-23
USIM PINs.....	1-11	Using ECO Mode.....	1-23
USIM Card Installation	1-12		
Battery & Charger	1-14		
Notes on Battery Charging.....	1-14		
Battery Installation	1-14		
Open Port Cover.....	1-16		
Charging Battery.....	1-17		
Power On/Off	1-18		
Power On.....	1-18		
Power Off	1-19		

1

Handset Parts







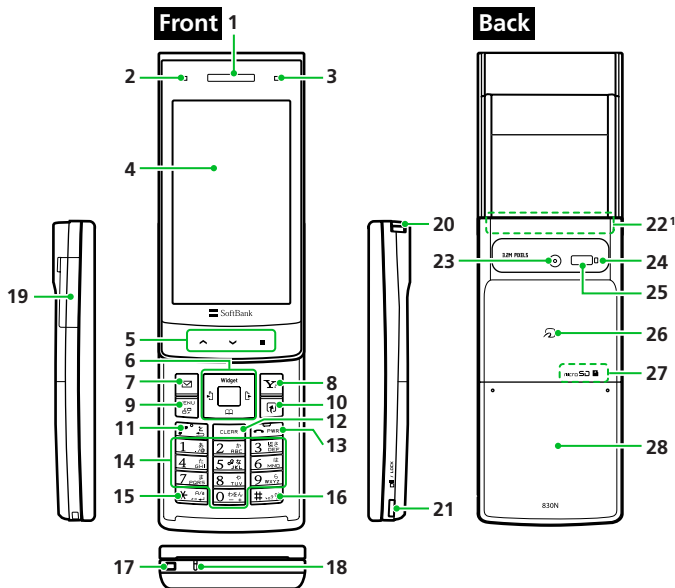









1

Getting Started

● SoftBank 830N



- 1 For optimal signal reception, do not cover Internal Antenna with hands or anything else. Do not put stickers over Internal Antenna.
- 2 Earpiece also functions as speaker. Be careful of ringtone/alarm sounding close by your ear when receiving or ending a call.
- 3 Key illustrations are simplified and differ in appearance from actual handset keys.
- 4 Battery Cover and Battery must be removed when installing memory card.

- | | |
|-----------------------------------|---|
| 1 Earpiece/Speaker ² | |
| 2 Charging Indicator/Illumination | |
| 3 Light Sensor | |
| 4 Display | |
| 5 Touch Sensor |   &  |
| 6 Multi Selector |  &  |
| 7 Mail Key |  |
| 8 Yahoo! Keitai Key |  |
| 9 Menu Key |  |
| 10 Shortcut Key |  |
| 11 Send Key |  |
| 12 Clear/Back Key |  |
| 13 Power/End Key |  |
| 14 Keypad |  -  |
| 15 *Key |  |
| 16 #/Manner Key |  |
| 17 Strap Eyelet | |
| 18 Microphone | |
| 19 External Device Port | |
| 20 TV Antenna | |
| 21 Side Key |  |
| 22 Internal Antenna | |
| 23 Camera | |
| 24 Camera Indicator | |
| 25 Infrared Port | |
| 26 FeliCa Mark | |
| 27 Memory Card Slot ⁴ | |
| 28 Battery Cover | |

Basic Key Operations



● In Standby (Handset Closed)

No.	Key/Operations	Description
5		Activate Quick Menu when Touch Sensor is on.
21		Turn Touch Sensor on/off.
	Press and hold	Set/cancel key operation lock.











● In Standby (Handset Open)





No.	Key/Operations	Description
6		Access widgets.
	Press and hold	Open S! Quick News List.
		Open Phone Book Search menu.
		Open Received Calls window.
	Press and hold	Open Received Address List.
		Open Redial window.
	Press and hold	Open Sent Address List.
		Access Desktop Icons.

No.	Key/Operations	Description
7		Open Mail menu.
	Press and hold	Compose a new message.
8		Access Yahoo! Keitai portal.
	Press and hold	Open Yahoo! Keitai menu.
9		Open Main Menu.
10		Activate function assigned to key.
	Press and hold	Assign a function to key.
11		Open Tomo-Den Window
12		Play messages on Answering Machine.
	Press and hold	Set/cancel Answering Machine.
13		Show/hide Desktop Page.
	Press and hold	Turn power on/off.
14	Press and hold	Set/cancel IC Card Lock.
	Press and hold	Set/cancel ECO Mode.
	Press and hold	Set font type, thickness and size.
	Press and hold	Set Privacy Angle on/off.







No.	Key/Operations	Description
14	Press and hold 	Enter “+” (international access code).
16	Press and hold 	Set/cancel Manner Mode.









● During Voice Calls

No.	Key/Operations	Description
6		Increase earpiece volume.
	Press and hold 	Continuously increase earpiece volume.
		Decrease earpiece volume.
	Press and hold 	Continuously decrease earpiece volume.
		Open Received Calls window.
		Open Redial window.
7		Turn handsfree on/off.
8		Toggle Hyper Clear Voice modes (High, OFF or Low).
9		Open Task Switch window.
10		Display function menu.
12		Hold call.

No.	Key/Operations	Description
13		End call.
	Press and hold 	Turn power off.
16	Press and hold 	Set/cancel Manner Mode.
21	Press and hold 	Record other party's voice.

● During Text Entry

No.	Key/Operations	Description
6		Insert line feed “↵” (when cursor is at the end of text).
		Add a space (when cursor is at the end of text).
7		Toggle character entry modes (in 5-touch or T9 input mode). Toggle double-byte and single-byte characters (in 2-touch mode).
	Press and hold 	Toggle text input methods (in 5-touch, 2-touch or T9 input mode).
8		Switch to pictograph/symbol list.
	Press and hold 	Access My Pictograms (in S! Mail).

No.	Key/Operations	Description
11		Cycle characters in reverse order (in 5-touch mode).
	Press and hold 	Undo last operation (conversion, pasting, cut, etc.) and return to the previous state.
12		Delete one character to right of cursor. When cursor is at end of text, a character to left is deleted.
	Press and hold 	Delete all text to right of cursor. When cursor is at end of text, delete all text.
15		Enter dakuten (*) or handakuten (°) (in 5-touch or 2-touch mode). Toggle case (in 5-touch or 2-touch mode). Insert line feed " ↓ . "
	Press and hold 	Select area.
16		Toggle Shift, Caps Lock and lower case modes (when entering alphanumerics in T9 input mode).
	Press and hold 	Paste copied or cut text.

Opening/Closing Handset

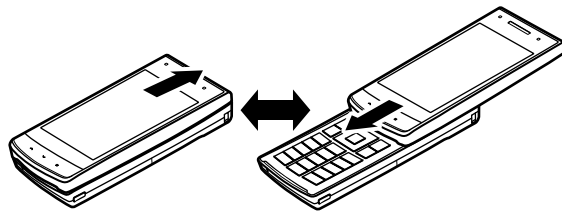

Slide Display open.

Slide Display shut.

Touch Sensor

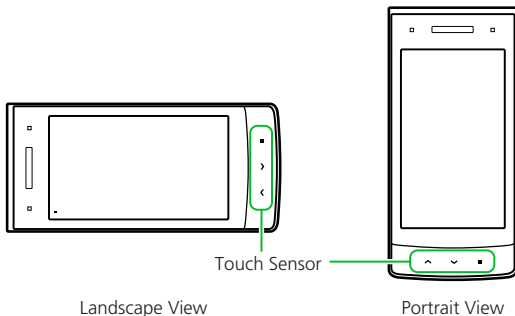

Use to operate Camera, TV, Music Player, etc., with handset closed.

- Touch Sensor is available in Landscape and Portrait Views.
Position handset as shown below.







- Use  (sidekey) to enable/disable Touch Sensor.
- Touch Sensor illuminates when enabled. When illumination is off, Touch Sensor is disabled.

Tip

- Touch Sensor is illustrated as , , or  in this guide.

Using Touch Sensor

- Lightly tap Touch Sensor (,  or .
- Use  or  to select pop-up options (e.g. YES/NO).

Note

- Simply tap Touch Sensor with finger. Do not use fingernails, ballpoint pens, pins or other sharp objects to tap Touch Sensor.

Tip

- Touch Sensor illumination color changes and handset vibrates upon sensor recognition. Color change and vibration are longer for a press-and-hold recognition.
- Pressing for 30 seconds turns Touch Sensor off and handset returns to Standby.

Display Indicators

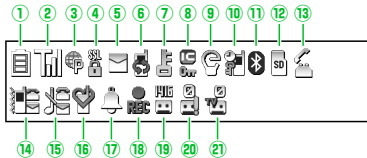

- ① Battery Level
- ② Signal Strength
OUT Out of Range
 Emission OFF Mode
 USIM Lock Active
- ③ Yahoo! Keitai Mode
 Yahoo! Keitai Communication in Progress
 Packet Transmission (No Data Transfer)
 Connecting to Network for Packet Transmission
 Packet Transmission (Sending/Receiving Data)
- ④ SSL Secured Site Connected
- ⑤ Unread Messages
 Handset Message Memory Full
 USIM SMS Memory Full (when there are unread messages)

- ⑥ Handset & USIM SMS Memory Full
- ⑦ Software Updated
- Secret Mode/Secret Data Only Mode
- Original Lock Active
- Original Lock Active in Secret Mode/Secret Data Only Mode
- Infrared Transmission
- Authenticating IC Card
- SI Addressbook Back-up Synchronizing
- ⑧ IC Card Lock Active
- ⑨ ECO Mode
- Privacy Angle On (when Backlight is Off)
- ⑩ Keypad Lock Active (**After Closed, Timer or Lock Key is ON***)
- ⑪ Bluetooth Communication in Progress
- Bluetooth Power Saving
- Bluetooth Call
- ⑫ Memory Card Inserted
- Invalid Memory Card Inserted
- Memory Card Reader/Writer in Use
- Accessing Memory Card
- ⑬ Voice Call
- Video Call
- Maximum Call Cost Limit Reached

- USB Cable Connected in Communication/microSD Mode
 - microSD Mode
 - Handsfree Device Connected in Communication/microSD Mode
 - USB Cable & Handsfree Device Connected in Communication/microSD Mode
 - ⑭ Vibration Set for Incoming Calls & Messages
 - Vibration Set for Incoming Calls/Messages
 - ⑮ No Ringtone for Incoming Calls & Messages
 - No Ringtone for Incoming Calls/Messages
 - ⑯ Manner Mode
 - Auto Manner Mode Start On
 - Auto Manner Mode Release On
 - ⑰ Alarm Set
 - Alarm Set for Today (appears prior to set time.)
 - ⑱ One Seg Timer Recording in Progress
 - ⑲ New Messages at Voice Mail Center
 - ⑳ - Voice Messages on Answering Machine
 - ㉑ - Video Messages on Answering Machine
- * **Lock Key is ON** by default.

Tip

- To see indicator descriptions:

⇒ **Settings** ⇒ ⇒ **Display** ⇒ ⇒ **Icons** ⇒

Mobile Widget (Japanese)

Set Widgets to appear on Desktop.

- For information about Mobile Widget, see P. 10-2.

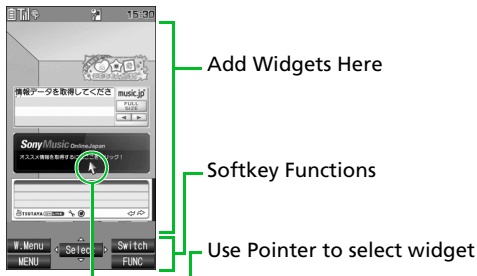

Desktop Page

Tip

- When Flash[®] is set to Standby and widgets appear, Flash[®] stops.

Key Illumination

Key backlight flashes in seven colors in a variety of patterns.

More Features

Customize

Display Settings

- Wallpaper
- Display Color Scheme
- Set Font Type
- Interface Language
- Guard from Prying Eyes
- Display Quality

▶ P. 14-4

Backlight

- Set Backlight & Power Saving

▶ P. 14-7

Standby Indicators

- Enable Indicator Selector

▶ P. 14-10

Key Illumination

- Set Illumination for Power On/Off
- Set Flashing Color for Power On/Off
- Set Flashing Pattern for Call Start
- Set Flashing Color for Call Start
- Set Illumination for Emotion-Expressing Mail
- Set Flashing Pattern for Alarm Notification
- Set Flashing Color for Alarm Notification
- Set Illumination for Snooze Notification

- Set Flashing Color for Snooze Notification
- Set Illumination for Ir/IC Transmission
- Set Flashing Color for Ir/IC Transmission
- Illuminate When Charging Begins
- Set Flashing Color (When Charging Begins)
- Set Flashing Pattern for Handset Open or Close
- Set Flashing Color for Handset Open or Close

(▶ P. 14-39)

Key Backlight

- Set Key Backlight Color
- Set Key Backlight Off

(▶ P. 14-41)

Before Using USIM Card

Universal Subscriber Identity Module (USIM) Card is an IC card that contains customer information (phone number, etc.). A USIM Card must be inserted to use your handset.

- Store Phone Book entries and SMS on USIM Card.
- Insert USIM Card into other USIM-compatible SoftBank handsets to use information on Card.
- Do not apply excessive force when inserting/removing USIM Card.
- SoftBank is not liable for any damage caused by inserting USIM Card into other IC card readers/writers.
- USIM Card may become warm during use. This is not a malfunction.
- Keep IC chip clean.
- For details, refer to the manual supplied with your USIM Card.
- Do not drop USIM Card or subject to excessive shock. Doing so may cause malfunction.
- Do not bend USIM Card or place heavy objects on it. Doing so may cause malfunction.
- Avoid extreme temperatures.
- Do not scratch, carelessly touch or short-circuit the IC chip. Doing so may result in data loss or malfunction.
- Clean USIM Card with a dry soft cloth (such as is used for eyeglasses).
- Use a SoftBank-designated USIM Card. Using a non-designated card may result in handset malfunction.

Other Notes on USIM Cards

- USIM Cards are the property of SoftBank.
- USIM Cards will be reissued for a fee if lost or damaged.
- Return USIM Cards to SoftBank upon cancellation or suspension of service.
- Returned USIM Cards are recycled.
- USIM Card specifications and performance may change without prior notice.
- Keep a separate copy of data saved on your USIM Card. SoftBank is not liable for lost data.
- If USIM Card or handset (with USIM Card inserted) is lost or stolen, suspend service immediately. For details, contact SoftBank Customer Center, General Information (P. 15-52).
- Downloaded files (S! Appli, videos, Saved Pages, etc.) saved to handset or memory card may be inaccessible after USIM Card replacement, handset upgrade or service subscription cancellation. If a different USIM Card is inserted, the cookies and cache are cleared to protect personal information.

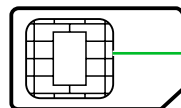

IC Chip

USIM PINs

There are two security codes for USIM Cards: PIN1 and PIN2.

PIN1

PIN1 is a four- to eight-digit code to prevent unauthorized handset use by a third party.

- Default PIN1 is 9999.
- PIN1 can be changed (P. 4-2).
- When *PIN1 Code Entry Set* is set to *ON*, PIN1 must be entered each time handset is turned on to be used.

PIN2

PIN2 is required to reset total call cost or to set a maximum limit to call costs.

- Default PIN2 is 9999.
- PIN2 can be changed (P. 4-2).

PIN Lock & Cancellation (PUK)

If PIN1 or PIN2 is incorrectly entered three times consecutively, PIN Lock is activated, limiting handset use to specific functions. Enter Personal Unblocking Key (PUK1/PUK2) to cancel PIN Lock.

- For information on PUK, contact SoftBank Customer Center, General Information (P. 15-52).

Note

- If PUK1 is incorrectly entered ten times consecutively, USIM Card is locked and handset is disabled.
- If PUK2 is incorrectly entered ten times consecutively, operations requiring PIN2 entry are all disabled.
- Write down your PUK.
- To cancel USIM Card lock, contact SoftBank Customer Center, General Information (P. 15-52).

USIM Card Installation

- Remove Battery (P. 1-15) before inserting or removing USIM Card.

Insertion

- 1 Pull Tray out by catch

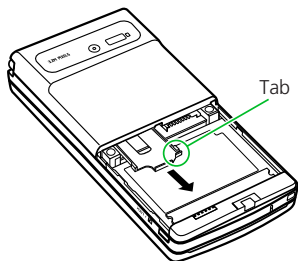

- 2 Place USIM Card on tray with gold IC part facing downward, in the orientation shown

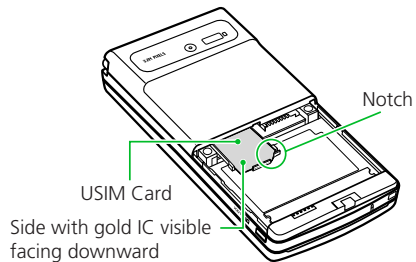

- 3 Push Tray all the way in

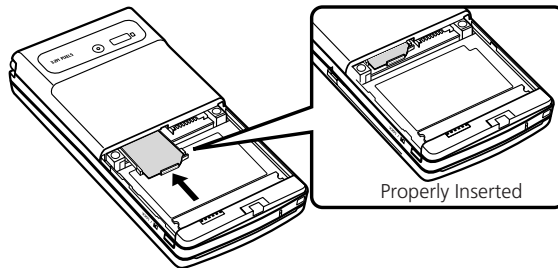

Removal

- 1 Pull Tray out by catch and remove USIM Card

If Tray Detaches

Do not use excessive force to pull Tray; may slide out completely.

If Tray detaches, face Tray properly and align with gold guide stripes, then push Tray in all the way.

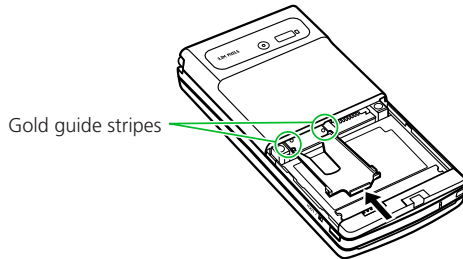

Notes on Battery Charging

- Charge battery at least once every six months. If battery is left uncharged for a long period, it may become unusable or its operation time may decrease.
- Avoid connecting too many things to one AC outlet. Doing so may cause the AC outlet to overheat and cause a fire.
- Battery and AC Charger may become warm during charging, but this is not a malfunction. If they become too hot, however, stop charging and contact SoftBank Customer Center, Customer Assistance (P. 15-52).
- If Charging Indicator flashes red during charging, battery may be faulty. Contact SoftBank Customer Center, Customer Assistance (P. 15-52).
- Depending on the conditions of usage, the battery may expand as it nears the end of its life. However, this presents no safety problems.
- Check the battery type on its label:

Mark	Type
Li-ion00	Lithium-ion battery Lithium-ion batteries are a recyclable resource. Do not dispose of them as municipal waste. Bring used batteries to your nearest SoftBank Shop or recycling center after insulating the terminals with tape. Observe local regulations on battery disposal.

Battery Installation

Insertion

- 1 Press and slide battery cover off

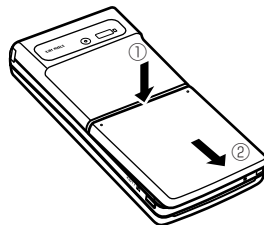

- 2 Insert battery into place

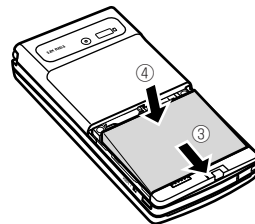

3 Replace cover

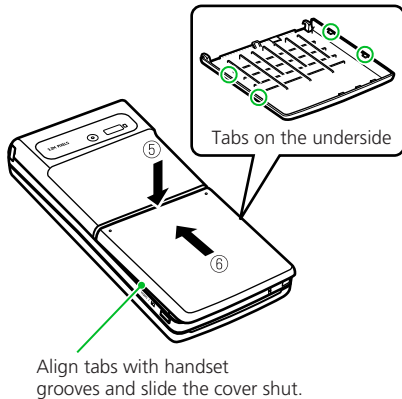

Removal

● Turn off handset before removing battery.

1 Remove battery cover

2 Pressing Tab (1), lift out battery (2)

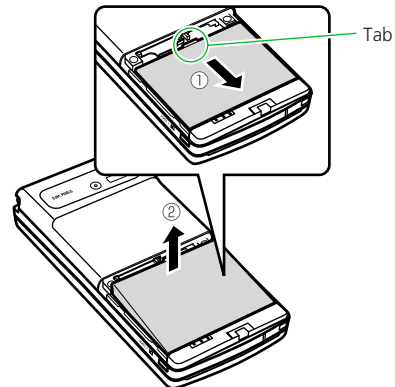

Note

- Do not force Battery Cover shut. Tab may be misaligned, and cause breakage.

Open Port Cover

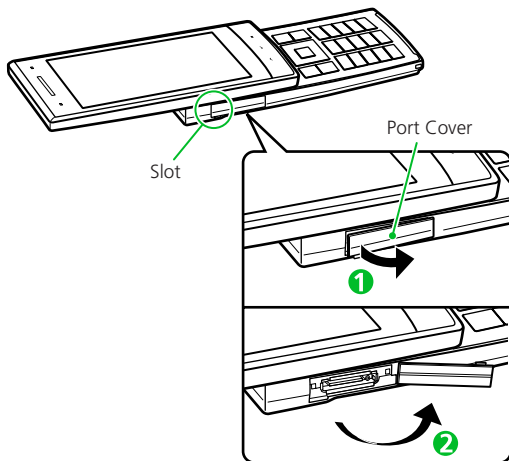

1 Pull Port Cover in direction of arrow

2 Rotate Port Cover (as indicated by arrow)

- Using excessive force may cause damage.
- Keep Cover completely open (as illustrated) while Port is in use.

Note

- When handset is connected to an external device, be cautious of Port Cover. Excessive force may damage it.

Charging Battery

Using AC Charger

Use only SoftBank-specified AC Charger "ZTDAA1" (sold separately). In this guide, the ZTDAA1 model AC Charger is referred to as "AC Charger."

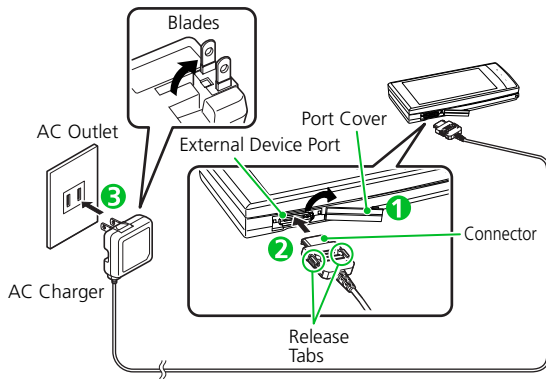

1 Open Port Cover

See P. 1-16.

2 Insert Charger connector into External Device Port

3 Extend Charger blades and plug into an AC Outlet

Charging Indicator lights red while charging. When charging is complete, Indicator goes out.

4 Disconnect connector from handset

Press and hold Release Tabs to remove connector.

5 Unplug Charger from AC Outlet

6 Close Port Cover

Note

- Battery can only be charged while inserted in handset.
- When Charging Indicator and Display Indicator  go out and **Charge Unusual Stop Charge** appears, disconnect handset from AC Charger and remove battery. Set up handset and Charger and start charging again. If the same error occurs, AC Charger may be faulty. Contact SoftBank Customer Center, Customer Assistance (P. 15-52).

More Features

Customize

Backlight

- Set Backlight during Charging

▶ P. 14-7

Power On

- Make sure USIM Card is correctly inserted before turning power on.

1 Press and hold

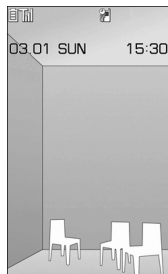

Tip

- If handset is turned on immediately after powering it off or inserting battery, *WELCOME* may appear in Display for a while.
- After USIM Card is replaced, Security Code is required when powering handset on for the first time. If Security Code is incorrectly entered five times, handset shuts down. Turn handset on again.

● Powering Handset On for the First Time (Initial Setup)

Setup prompt appears in Japanese.

Select **NO** and press  to exit.



After changing interface language to English (P. 14-6), restart handset and perform setup procedure as follows.



1 [Initial Settings] window

YES  

2 **Auto** **Select a time zone**

■ **To Manually Enter Date & Time**

 **Manual (Date Time Set)**  

 **Select a time zone**  

Enter date and time  

3 **Enter Security Code (9999)**

   **Enter new Security**

Code    **YES**  

4 **Select a font size**

■ **When *Separate Setting* is Selected**

Set a font size for each function window (P. 14-6).



5 [Keypad Sound Setting] window

 **ON or OFF**  













Tip

- Setup prompt no longer appears when all the initial setup items have been set.
- The default Security Code is 9999.

● Retrieving Network Information

When , , or  is pressed after initial setup, a prompt appears. Select **YES** to update network settings.

Tip

- Retrieve network information to use network-related services, such as mail and the Internet.
- To manually update network settings:
  **Settings**    **Connection Settings**    **Retrieve NW Info**    **YES**  

Power Off

- 1 Press and hold 
Handset shuts down.

More Features

Customize

Clock

- Hide Clock
 - Set Auto Time Adjustment
 - Manually Adjust Time
 - Summer Time
 - Time Zone (Sub Clock)
 - Hide Sub Clock
 - Summer Time (Sub Clock)
 - Time Zone Major City (Sub Clock)
- (▶ P. 14-2)

Auto Power On/Off

- Set Auto Power On/Off
- (▶ P. 14-3)

Display Settings

- Set a Wake-up Image
 - Set a Wake-up Message
 - Set Font Sizes Collectively
 - Set Font Size for Each Function Window
- (▶ P. 14-4)

Sounds

- Set Handset Open/Close Sound
- (▶ P. 14-14)

Key/Touch Sensor

- Set No Sound at Key/Touch Sensor Touch
- (▶ P. 14-38)

Use your handset responsibly.

Inappropriate handset use can be both dangerous and bothersome. Take care not to disturb others when using your handset. Adjust handset use according to your surroundings.

- Turn handset power off in theaters, museums and other places where silence is the norm.
- Refrain from use in restaurants, lobbies, elevators, etc.
- Observe signs and instructions regarding handset use aboard trains, etc.
- Refrain from use that interrupts the flow of pedestrian or vehicle traffic.

Activating Manner Mode

Most handset sounds are muted in Manner Mode.

1 Press and hold

■ To Cancel Manner Mode

⇨ Press and hold 

Note

- When handset is set to vibrate for incoming calls, be careful as handset may slide off, slide into a stove, etc.

Tip

- Shutter click sounds even in Manner Mode.
- Press and hold  to set or cancel Manner Mode during a call. Short beeps sound through the earpiece when Manner Mode is set or canceled during a call.

More Features

Customize

Manner Mode

- Set Manner Mode Type
- Configure Original Manner Mode
- Set Time for Auto Manner Mode Start
- Set Time for Auto Manner Mode Release
- Toggle Auto Manner Mode Start and Release On/Off

 **P. 14-13**

Security Code, Center Access Code and Network Password are required to use handset.

- Do not reveal these codes to others. Write down your codes.
- SoftBank is not liable for any damage due to handset misuse.

Security Code







Security Code, 9999 by default, is required to use some handset functions. The code can be changed.

- If Security Code is entered incorrectly or nothing is entered for 15 seconds, a tone sounds and a message appears. Enter correct Security Code.
- Security Code is referred to as 操作暗証番号 (operation code) on SOFTBANK MOBILE Corp. Website (<http://www.softbank.jp>).

Note

- The warning tone does not sound in Manner Mode or when *Keypad Sound* is set to *OFF*.

Changing Security Code

- 1  ⇒ **Settings** ⇒  ⇒ **Security** ⇒  ⇒ **Change Security Code** ⇒ 
- 2 **Enter current Security Code** ⇒ 
- 3 **Enter new Security Code** ⇒  ⇒ **YES** ⇒ 

Center Access Code

Center Access Code, a four-digit code assigned at initial subscription, is required to access Optional Services via landlines or to subscribe to fee-based information.

Network Password

Network Password, a four-digit code assigned at initial subscription, is required to use Call Barring.

- If Network Password is incorrectly entered three times, Call Barring settings are locked. Network Password and Center Access Code must be changed.

Checking Battery Level

Use Battery Level meters as a guide only.

Battery Level Indicator

Battery Level indicator appears at top of Display.

- Sufficient
- Low
- Almost out. Charge immediately.
- (Flashing) Charging

Battery Level Beeper & Large Indicator

Check battery level by number of beeps and large indicator.

- 1 ⇒ **Settings** ⇒ ⇒ **Other Settings** ⇒ ⇒ **Battery Level** ⇒

A large battery level indicator appears. Beeps sound according to the battery level.
 Three short beeps: Sufficient
 Two short beeps: Low
 One short beep: Almost out.
 Charge immediately.

Note

- The battery level beeper does not sound in *Manner Mode* or when *Keypad Sound* is set to *OFF*.

● When Battery Is Empty

Recharge Battery appears, the battery alarm sounds for about 10 seconds, and handset powers off in about 60 seconds. Charge battery.

My Phone Number

Check handset phone number.

- 1 ⇒ ⇒ Account Details appear.
- **Add Other Information**
 ⇒ ⇒ Enter Security Code ⇒ ⇒ Select an item ⇒ ⇒ Enter information ⇒ ⇒
 - **View All Information**
 ⇒ ⇒ **Display All Data** ⇒ ⇒ Enter Security Code ⇒ ⇒ to switch tabs
 - **Reset Account Details**
 ⇒ ⇒ **Reset** ⇒ ⇒ **YES** ⇒

Checking Network Status

Check Network Status to confirm if voice calls and/or packet transmission is available.

- 1 ⇒ **Settings** ⇒ ⇒ **Other Settings** ⇒ ⇒ **Network Status** ⇒
 Network information appears.

Dialing	Packet Transmission	Description
not available	not available	Voice calls/packet transmission not possible.
available	not available	Voice calls possible, packet transmission not possible.
not available	available	Voice calls not possible, packet transmission possible.

Dialing	Packet Transmission	Description
available	available	Voice calls/packet transmission possible.

“Out of Service Area” appears when out of range.

Stereo Earphone Conversion Cable

Use Stereo Earphone Conversion Cable (sold separately) to connect an earphone.

Using ECO Mode

When set to ECO Mode, light, sound, and Display settings are modified to decrease battery consumption.

1 Press and hold

ECO Mode is set, and “” appears.

■ Canceling

⇨ Press and hold 

Note

- ECO Mode is canceled when power is turned off and on again.

