

Thank you for purchasing SoftBank 105SH.

For proper handset use, read "Quick Tips" (in お願いとご注意) and this guide beforehand.

- Accessible SoftBank Mobile services may vary by subscription, etc.
- SoftBank 105SH is compatible with 3G and GSM network technologies.
- Most operation descriptions are based on default settings\* with handset open (P.1-1) in Standby (P.1-6).
- Operations and results may differ by handset status.
- Sample screenshots, etc. are provided for reference only; actual handset windows, menus, etc. may differ in appearance.
- In this guide and on handset, "abroad" means "outside Japan" with regard to handset/service usage.

\*With the exception that Handset Code and Administrator Code are saved.

Guide Usage Notes .....	i	Handling Messages .....	4-6
Table of Contents .....	ii	PC Mail .....	4-8
<b>1 Getting Started</b>		<b>5 Internet</b>	
Handset Parts .....	1-1	Internet Services .....	5-1
Battery & USIM Card .....	1-3	Yahoo! Keitai .....	5-2
Charging Battery .....	1-5	PC Site Browser .....	5-3
Power On/Off .....	1-6	Browsing .....	5-4
Display & Indicators .....	1-7	<b>6 Connectivity &amp; File Backup</b>	
Main Menu .....	1-12	Infrared .....	6-1
Menu List .....	1-13	PC Connection .....	6-4
Security Codes .....	1-15	Backup .....	6-5
Mobile Etiquette .....	1-17	<b>7 Camera</b>	
My Details & Basic Settings .....	1-18	Using Camera .....	7-1
World Clock .....	1-19	Photo Camera .....	7-2
Memory Card .....	1-20	Video Camera .....	7-3
<b>2 Universal Operations, Etc.</b>		Review .....	7-4
Text Entry .....	2-1	Shooting Modes .....	7-5
Fonts .....	2-6	<b>8 Additional Functions</b>	
Wallpaper .....	2-7	Digital TV .....	8-1
Sounds & Alerts .....	2-8	Media Player .....	8-7
<b>3 Calling</b>		<b>9 Customer Support</b>	
Emergency Calls .....	3-1	Customer Service .....	9-1
Voice Calling .....	3-2	Software Update .....	9-2
Video Calling .....	3-4	<b>10 Safety Precautions</b>	
Optional Services .....	3-5		
Phone Book .....	3-7		
<b>4 Messaging</b>			
Customizing Handset Address ....	4-1		
Sending Messages .....	4-2		
Customizing Message Retrieval ....	4-5		

## Parts & Functions

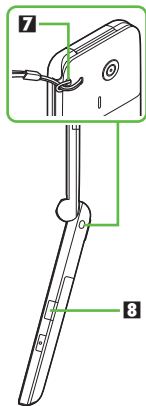
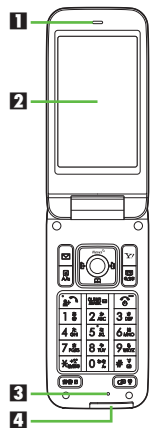

- 1** Earpiece
- 2** Display
- 3** Mic
- 4** External Device Port (with Port Cover)
- 5** Notification Lamp
- 6** Sub-display
- 7** Strap Eyelet
- 8** Infrared Port
- 9** Internal Antenna Area
- 10** Camera (Lens Cover)
- 11** Speaker
- 12** Battery Cover

- Do not cover or place stickers, etc. over Internal Antenna area.
- Close Port Cover after External Device Port use.
- Avoid metal Straps; may affect signal reception.

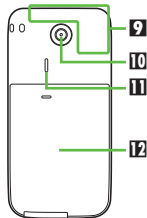
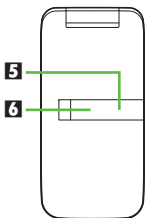

### Handset Positions

#### Handset Closed

Keep handset closed when not in use.



#### Handset Open

Open handset to place or answer calls, enter text, etc.



## Handset Keys

- Keys are indicated in this guide as shown.
- Change assigned functions indicated \* with Set Key Shortcut.

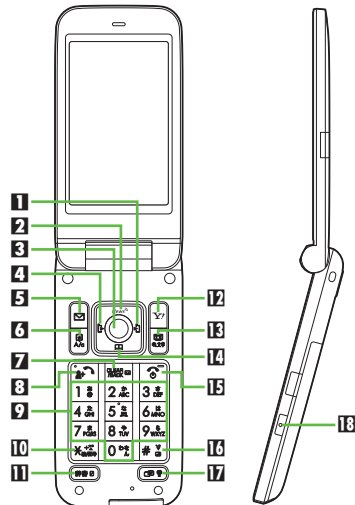

- 1 Multi Selector (right)** Open Call Log (Received). Long Press to activate/cancel Infrared.
- 2 Multi Selector (up)** Open S! Quick News (Standby Window). Long Press to open PC Site Browser menu.

- 3 Center Key** Open Main Menu. Long Press to activate/cancel Keypad Lock.
- 4 Multi Selector (left)** Open Call Log (Dialed). Long Press to open Speed Dial/Mail.
- 5 Mail Key** Open Messaging menu. Long Press to open S! Mail Composition window.
- 6 Shortcuts & A/a Key** Open Shortcuts. Long Press to show active indicators (Status Icon List).
- 7 Clear/Back Key** Play Answer Phone messages. Long Press to activate/cancel Answer Phone.
- 8 Start & Rakutomo Link Key** Open Rakutomo Link. Long Press to open Double Number Mode menu.
- 9 Keypad** - Enter numbers to place calls or access functions. Long Press to open Phone Book.
- 10 \* Key** Enter \*, +, P, ? and -.
- 11 Dictionary Key** Open Dictionary. Long Press to activate/cancel VeilView.
- 12 Yahoo! Keitai Key** Open Yahoo! Keitai portal. Long Press to open Yahoo! Keitai menu.
- 13 TV & Text Key** Activate TV. Long Press to open Change Menu.

- 14 Multi Selector (down)** Open Phone Book. Long Press to open Exchange Profile.
- 15 Power On/Off & End Key** Toggle Standby display. Long Press to power off.
- 16 # Key** Enter #. Long Press to activate/cancel Manner mode.
- 17 Multi Job & Manner Key** Select handset mode. Long Press to activate/cancel Manner mode.

## Side Key

- 18 Shutter Key** **Handset Open:** Long Press to activate Camera.  
**Handset Closed:** Toggle Clock view.

## Multi Selector

- In this guide, Multi Selector operations are indicated as follows:

Press  or	
Press  or	
Press , ,  or	

# Battery & USIM Card Installation

Do not apply excessive force to Battery or USIM Card.

## Inserting

### 1 Remove Battery Cover

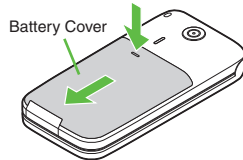

- Press and slide as shown.

### 2 Use Tab to pull out USIM Tray

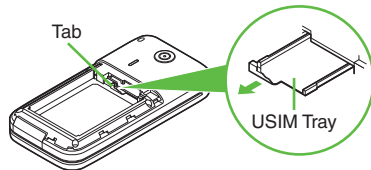

### 3 Slide in USIM Card with IC chip facing up

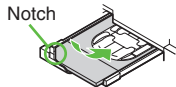

### 4 Secure USIM Tray



### 5 Insert Battery

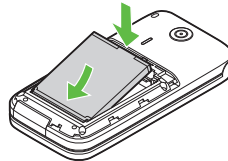

- With logo side facing up, align battery terminals with contacts.

### 6 Replace Battery Cover

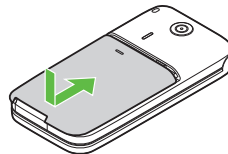

- Position and slide Battery Cover gently as shown all the way.

#### Precaution

- USIM Card Slot is directly below Memory Card Slot. Do not insert USIM Card into Memory Card slot.

## Removing

Power off first.

### 1 Remove Battery Cover

### 2 Remove Battery

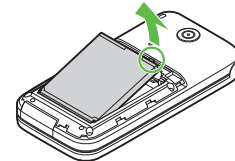

- Lift Battery as shown.

### 3 Use Tab to pull out USIM Tray

### 4 Lift and slide out USIM Card

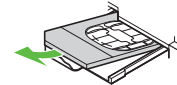

- After removing USIM Card, secure USIM Tray, insert Battery and replace Battery Cover.
- Take care not to lose removed USIM Card.

#### After USIM Card Removal (Contract Termination, Handset Upgrade/Replacement, Repairs, Etc.)

- Some files on handset and Memory Card may be inaccessible. Inserting another USIM Card may disable S! Appli and BookSurfing®.

## About Battery

- Charge Battery at least once every six months; uncharged Battery may die or affect files/settings.
- Depending on usage, bulges may appear near end of battery life; this does not affect safety.
- Replace Battery if operating time shortens noticeably.
- Clean battery terminals and charging terminals with dry cotton swabs.

### Lithium-ion Battery

- This product requires a lithium-ion battery. Lithium-ion batteries are a recyclable resource.



Li-ion00

- To recycle a used lithium-ion battery, take it to any shop displaying the symbol shown above.
- To avoid fire or electric shock, do not short-circuit or disassemble Battery.

## About USIM Card

USIM Card is an IC card containing customer and authentication information, including handset number. Save contacts on USIM Card Phone Book to use them on other SoftBank handsets. Depending on USIM Card in use, some entry items may not be supported, and some limits (character entry, etc.) may be lower.

### Precautions

- Do not insert USIM Card into any other IC card device. SoftBank Mobile is not liable for resulting damages.
- Keep USIM Card IC chip clean; debris may cause malfunction. Clean with soft dry cloth.
- Do not attach labels to USIM Card. Malfunction may result.

### Important

- USIM Card is the property of SoftBank Mobile.
- USIM Card will be reissued for a fee if lost or damaged, etc.
- Return USIM Card to SoftBank Mobile upon contract termination.
- Returned USIM Cards are recycled.
- USIM Card specifications may change without prior notice.
- Keep a copy of information saved on USIM Card in a separate place. SoftBank Mobile is not liable for loss of information.
- If USIM Card or handset (with USIM Card inserted) is lost or stolen, suspend your service immediately. For details, contact SoftBank Customer Support, General Information (P.9-1).

## USIM PIN

**9999** by default; activate PIN Entry to restrict handset use.

### PIN Lock

- Entering incorrect PIN three consecutive times activates PIN Lock, limiting handset use.

### Canceling PIN Lock

- Contact SoftBank Customer Support, General Information (P.9-1) for your Personal Unblocking Key (PUK) and follow these steps:

Enter PUK ➔  ➔ Enter new PIN ➔

➔ Re-enter new PIN ➔

- Do not forget PUK; write it down if necessary.

### PUK Lock

- Entering incorrect PUK ten consecutive times activates PUK Lock, disabling handset. For recovery, USIM Card must be reissued at a SoftBank Shop (fees apply).

## Charging Battery (AC Charger)

Battery must be inserted in handset to charge it.

- Use specified AC Charger **ZTDAA1** (sold separately) only. In this guide, ZTDAA1 is referred to as "AC Charger."
- Handset/AC Charger may become warm while charging.

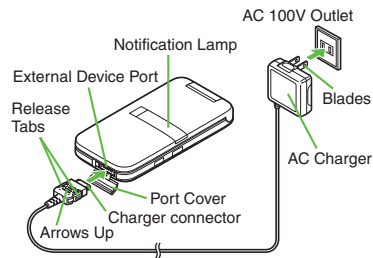

### Important AC Charger Usage Note

- Retract blades after charging. Do not pull, bend or twist cord.

### 1 Open Port Cover as shown

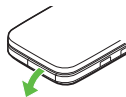

### 2 Insert Charger connector

- With arrows facing up, insert Charger connector until it clicks.

### 3 Extend blades and plug AC Charger into AC outlet

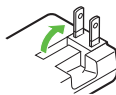

- Notification Lamp illuminates red while charging.
- Notification Lamp goes out when Battery is full.

### 4 Unplug AC Charger

### 5 Remove Charger connector from handset

- Squeeze release tabs and pull straight out.

### 6 Close Port Cover

#### When Notification Lamp is Flashing

- Battery is unchargeable; may be defective or simply at the end of its life; replace it.

## Handset Power On/Off

### Power On

Described for initial power on.

#### 1 (Long Press)

- After Power On Graphics, follow these steps:

→ → → → → **設定**  
 → → **Language** → → **English**  
 → → (Long Press) →   
 (Long Press) → Change Menu opens

#### 2 Select option →

Guide descriptions are based on Standard Menu.

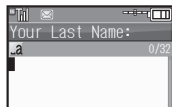

- My Details setup starts.

#### 3 Enter last name → → Enter first name →

- Change Menu display option appears.

#### 4 Yes or No →

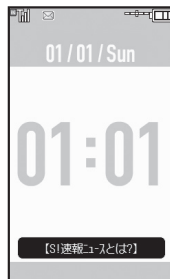

Standby

- Choose **No** to enter Standby immediately after powering on.

#### When USIM Card is Not Installed

- **Insert USIM Card** appears; handset is unusable.

### Retrieving Network Information

A prompt appears when , or is pressed for the first time.



To use Network-related services and TV: (Clock will be set automatically.)

#### 1 Yes → → Retrieval starts

#### 2

### Power Off

#### 1 (Long Press)

- After Power Off Graphics, handset shuts down.



## Display

### Standby



Indicators (signal strength, battery strength, etc.) appear.

### Indicator Descriptions

Check active indicators and their descriptions. (Status Icon List)

#### 1 (Long Press)



- Active indicators are enlarged; description for selected indicator appears.
- Use to select indicators to view their descriptions.
- Press to access corresponding function (e.g., Battery Meter from battery strength indicator); may be unavailable for some indicators.

### Information Window

Opens at the bottom for missed calls, new mail, etc.

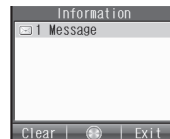

Information Window

Information label (e.g., **Message**, etc.) and count appear. Select an item and press to open it.

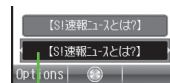

### Standby Window

View S! Quick News information (weather forecast, news, etc.) in Standby.



Standby Window

### Softkeys



Functions/operations assigned to ,  and  appear at the bottom of Display.



### Display Saving

Display goes dark after Display Saving time elapses. Press any key (except  during a call) to activate it.

#### Backlight

- Backlight turns off after Time Out time elapses. Press  -  to illuminate it (key press may affect active function).
- Display goes dark during a call. (Backlight does not turn off first.)

# Indicators

## Display Indicators

When Double Number is set to Dual Mode, line type appears at the bottom right of some indicators.

### Basic Status

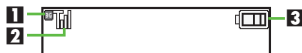

1		Within 3G Network
		Within GSM Network
		Roaming
2		Signal Strength <sup>1</sup>
3		Battery Strength <sup>2</sup>

<sup>1</sup> More bars indicate stronger signal.

<sup>2</sup> Flashes while charging; battery strength % (appears when Display activates, etc.) is an approximation.

### Function Status



1		S! Appli Active
		S! Appli Paused
		Music Playback
2		TV Recording
		Memory Card Inserted
		Accessing Memory Card
		Reading Memory Card
		Formatting Memory Card
		TV Timer/TV Recording Timer Set
3		Multiple Functions (Multi Job) Active

### Notifications

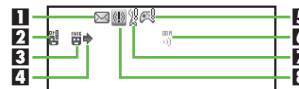

1		Unread Mail
		Unread Delivery Report
2		Answer Phone Active & Message Recorded
		Answer Phone Canceled & Message Recorded
3		New Voicemail
4		Missed Call or New Mail on Idle Line
5		S! Appli Notification
6		Contents Key Received
7		Unread S! Information Channel Info
		Software Update Result
8		Unread S! Quick News Info
		Unread Urgent News

### Warnings



1		Mail Memory Low
2		Message Delivery Failure
3		Memory Card Unusable/Misinserted

■ Transmissions

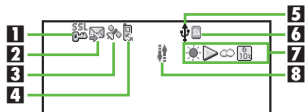

1		SSL Browsing
		Packet Transmission Active
2		Receiving Mail
		Sending Mail
3		Positioning*
4		Updating Software
5		USB Cable Connected
		USB Transmission Active
		Infrared Transmission Active
		Infrared File Transfer
		S! Addressbook Back-up Transmission Active
6		PC Site Browser in Use
		RSS-compatible Site
7		Weather Indicator
8		Infrared Active

\*Flashes while positioning.

■ Settings

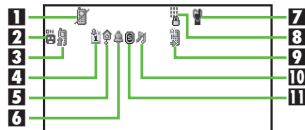

1		Offline Mode
2		Answer Phone Active
3		Call Forwarding or Voicemail Active (forwarding condition: <b>Always</b> *)
4		Schedule/Task (Alarm Set)
		Schedule/Task (Alarm Unset)
5		Hour Minder Active
6		Alarm Set
		Wakeup TV Set
7		Manner Mode
		Drive Mode
		Original Mode
		VeilView Active

8		Keypad Lock Active
9		Auto Answer or Remote Monitor Active
10		Ringtone (Silent)
		Ringtone (Increasing Volume)
		Vibration for Incoming Voice/Video Calls Active
11		Show Secret Data Active
		Function Lock (Once) Active

\*Indicator does not appear when Call Forwarding is set to Video Calls only, with Voicemail unset.

## Sub-display Indicators

### Basic Status



**1** Signal Strength<sup>1</sup>

**2** Battery Strength<sup>2</sup>

<sup>1</sup>More bars indicate stronger signal.

<sup>2</sup>Flashes while charging.

### Notifications

	Missed Calls
	Answer Phone Message Recorded
	Missed Call Notification
	New Voicemail
	Unread Mail
	Unread Delivery Report
	Contents Key Received
	Unread S! Information Channel Info
	Weather Indicator Update
	S! Appli Notification
	Unread Urgent News
	Location Info Request
	Auto Backup Complete
	Auto Backup Canceled

### Warnings

	Message Delivery Failure
	S! Information Channel Info Reception Failure
	Weather Indicator Update Failure
	Auto Backup Failure

### Handset Status

	Alarm
	Schedule Alarm
	Task Alarm
	TV Alarm (Watch)
	TV Alarm (Record)

### Activating Sub-display



### Sub-display Clock

- Press  to toggle view.



## Main Menu

### Selecting Menu Items



1 



- Main Menu opens.

2  Select menu item → 



- Menu/window opens.
- If submenu opens, use  to select an item and press .

### Tabs

- Menus/lists in a single window appear on separate tabs; use  to toggle tabs.

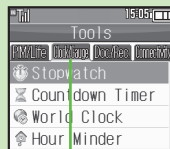

### Tab

#### Reverse Navigation

- Press . If confirmation appears, follow onscreen prompts.

#### Returning to Standby

- Press . If confirmation appears, follow onscreen prompts.

#### Simple Menu

- Simplify menus and enlarge fonts; ideal for users who use only basic handset functions.

### Main Menu Items

<b>Messaging</b>	Open/create messages, etc.
<b>Yahoo!</b>	Browse the Internet
<b>S! Appli</b>	Use S! Appli including games
<b>Entertainment</b>	Read e-Books, receive news updates, etc.
<b>Camera</b>	Capture photos or record video
<b>Media</b>	Play/download media files
<b>Tools</b>	Manage schedules, set Alarm, scan QR Codes, etc.
<b>Data Folder</b>	Open files saved on handset/Memory Card
<b>Calendar</b>	Use Calendar
<b>TV</b>	Watch/record TV programs
<b>Phone</b>	Search contacts, add entries, etc.
<b>Settings</b>	Customize handset interface, sounds, etc.

# Menu List

## Messaging

Received Msg.
Create Message
Retrieve New Msg.
Drafts
Templates
Sent Messages
Unsent Messages
Chat Folder
Server Mail Box
Create New SMS
Settings
Memory Status

## Yahoo!

Yahoo! Keitai
Menu List
Bookmarks
Saved Pages
Web Search
Enter URL
History
PC Site Browser
Browser Settings

## S! Appli

S! Appli Library
Settings
Information

## Entertainment

S! Information Channel/Weather
S! Quick News
Urgent News
Free Contents
S! Contents Store
Blog Tool
BookSurfing
e-Book Viewer

## Camera

Photo Camera
Video Camera
Barcode Reader
Scan Card
Scan Receipt
Kanji Grabber
Review
Photo Settings
Video Settings

## Media

Music
Videos

## Tools

### ■ PIM/Life

Alarms
Exchange Profile
Wakeup TV
Relaxation Time
Tasks
Household Accounts
Calculator
Expenses Memo
Simulated Call

### ■ Clock/Gauge

Stopwatch
Countdown Timer
World Clock
Hour Minder
Battery Meter

### ■ Doc./Rec.

Dictionary
Search
Notepad
Scratch Pad
ASCII Art
Voice Recorder
Barcode/Scan
Phone Help

## ■ Connectivity

Infrared
Card Reader Mode
USB Charge
Memory Card
Backup/Restore

## Data Folder

Pictures
DCIM
Ring Songs-Tones
S! Appli
Music
Videos
Books
Customized Screen
Flash®
Other Documents
Memory Status

## Calendar

## TV

Digital TV
TV Player
TV Link
TV Listing
Reservation List
Settings

## Phone

Phone Book
Add New Entry
Information
Call Log
Play Messages
Play Voicemail
S! Addressbook Back-up
My Details
Set Category
Mail Groups
Rakutomo Link
Speed Dial/Mail
Touch-Tone Signal List
Settings/Manage

## Settings

## ■ Sound/Display

Mode Settings
Display
Customized Screen
Sounds & Alerts
Date & Time
言語選択 (Language)
Ringer Output
Earpiece Volume
Change Menu

## ■ Phone/☎

User Dictionary
Set Key Shortcut
Set Key Light
Double Number
Memory Card
Backup/Restore
Locks
Software Update
Master Reset

## ■ Call

Call Time/Data Counter
Answer Phone
Voicemail/Call Forwarding
Video Call
Caller ID
<input type="checkbox"/> Missed Calls
Int'l Calling
Call Barring
Auto Answer
Call Waiting

## ■ Network

Select Network
Select Service
Re-search Signal
Offline Mode
Retrieve NW Info
Location Info
Network Info
External Device
Technical Regulations
Conformity Certification



## Security Codes

These codes are required for handset use. (Save Handset Code and Administrator Code beforehand.)

- Guide descriptions are given assuming that Handset Code and Administrator Code are saved.
- Do not forget Security Codes.
- Do not reveal Security Codes. SoftBank Mobile is not liable for misuse or damages.

<b>Handset Code*</b>	Use or change some functions
<b>Administrator Code*</b>	Required for Reset Settings and Reset All
<b>Center Access Code (Network Password)</b>	Four-digit code in contract; change contract details, access Optional Services from landlines, or set incoming/outgoing call restrictions

\*Save/change on handset.

### If Security Code is Unsaved

- Code setup message/window appears whenever Security Code is required.
- Incorrect Code Entry**
- Message appears for incorrect code entries; retry.
  - Incoming/outgoing call restriction settings will be locked if incorrect Center Access Code (Network Password) is entered three times consecutively when making a setting. To unlock, Center Access Code (Network Password) must be changed.
    - If you have previously changed Network Password on a SoftBank handset, enter the latest code to set incoming/outgoing call restrictions.

### Saving Handset Code

Enter four to eight digits.

1 ➔ **Settings** ➔ ➔

2 **Locks** ➔



Locks Menu

3 **Handset Code Settings** ➔

4 **Save Handset Code** ➔

5 **Enter Handset Code** ➔

6 **Re-enter Handset Code** ➔

### Changing Handset Code

After 4, enter current Handset Code ➔

➔ Enter new Handset Code ➔

➔ Re-enter new Handset Code ➔

## Saving Administrator Code

Enter four to eight digits.

- 1 In Locks menu, **Administrator Setting** ➔
- 2 **Register Administrator Code** ➔
- 3 **Enter Administrator Code** ➔
- 4 **Re-enter Administrator Code** ➔

## Changing Administrator Code

After 2, enter current Administrator Code

- ➔  ➔ Enter new Administrator Code
- ➔  ➔ Re-enter new Administrator Code
- ➔

## Need/UnNeed Setting

For enhanced security, set Need/UnNeed Setting to **Need**; then Handset Code will be required to delete all files/entries, etc.

- 1 In Locks menu, **Handset Code Settings** ➔
- 2 **Need/UnNeed Setting** ➔
- 3 **Need** ➔  ➔ Enter Handset Code ➔

## Manner Mode & Offline Mode

Please use your handset responsibly. Take care not to disturb others when using your handset.

- Power off in theaters, museums and other places where silence is the norm.
- Refrain from use in restaurants, hotel lobbies, elevators, etc.
- Observe signs and instructions regarding handset use aboard trains, buses, etc.
- Refrain from use that interrupts the flow of pedestrian or vehicle traffic.

### Activating Manner Mode

Mute most handset function sounds.



#### 1 (Long Press)



- Manner mode activates.

#### When Manner Mode is Active

- Ringtones and other sounds are muted.
- Handset vibrates for transmissions/alerts.
- Shutter click still sounds at fixed volume.
- To unmute Speaker temporarily while playing music, etc.:

During playback,  ➔  ➔ **Yes or No** ➔  ➔ **Adjust Volume**

#### Canceling Manner Mode

 (Long Press)

### Activating Offline Mode

Suspend signal transmitting functions.

#### 1 ➔ **Settings** ➔ ➔



#### **Network**

#### 2 **Offline Mode** ➔

#### 3 **On** ➔

- Offline Mode activates.

#### Canceling Offline Mode

In  **Off** ➔ 











## My Details & Basic Settings

### Handset Number & Address

1     

- Handset number, mail address (unsaved by default) and the name entered at initial setup appear.





#### Editing My Details

After 1,  (select tab)  Select item    Select item    Edit  

### Date & Time



1   **Settings**    In Sound/Display menu, **Date & Time**  

2 **Set Date/Time**  

3 Enter the year  Enter the month  Enter the day  Enter the time  

### Language

1   **Settings**    In Sound/Display menu, **Language** or 言語選択  





2 **English** or 日本語  

## Opening World Clock





### Auto World Clock

Powering on outside Japan automatically sets World Clock; the local time for your current location appears in Standby. Upon returning to Japan, original World Clock setting and Clock view will return.

### Disabling Auto World Clock

- 1  ➔ **Settings** ➔  ➔ **In Sound/Display menu, Date & Time** ➔ 
- 2 **Auto World Clock** ➔ 
- 3 **Disabled** ➔ 

### Setting World Clock Manually

- 1  ➔ **Tools** ➔  ➔   
**Clock/Gauge** ➔ **World Clock** ➔ 



- 2 

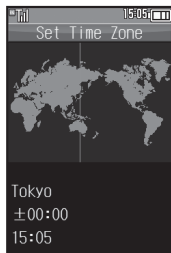



Set Time Zone Window

- 3  ➔ **Select area** ➔ 





- 4  ➔ **Standby returns**

### Advancing One Hour (Daylight Saving)

[Set Time Zone Window] 

- To cancel, press .

### Adding Custom Time Zone

[Set Time Zone Window]  ➔ **Enter city name** ➔  ➔  + or - ➔  ➔ **Enter time difference** ➔ 

### Opening World Clock in Standby Manually

- 1  ➔ **Settings** ➔  ➔ **In Sound/Display menu, Display** ➔ 

- 2 **Standby Display** ➔ 

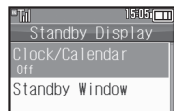

- 3 **Clock/Calendar** ➔ 

- 4 **World Clock (L), etc.** ➔ 

- 5  ➔ **Standby returns**

## Using Memory Card

### About Memory Card

Use microSD/microSDHC Memory Card to save and organize files for use on handset.

- Use recommended Memory Cards only. For details, contact SoftBank Customer Support, General Information (P.9-1).
- **If Memory Card is inserted, captured photos, downloads and other files are saved to Memory Card. (My Pictograms and Graphic Mail templates are saved to handset.)**

### Important Memory Card Usage Notes

- Do not force Memory Card into or out of handset.
- Keep Memory Card out of infants' reach; may cause choking if swallowed.
- Do not touch terminals or expose them to metal objects.
- SoftBank Mobile is not liable for any damages resulting from accidental loss/alteration of information. Keep a copy of contacts, etc. in a separate place.
- Never power off or remove Battery while files are being accessed.
- Be careful not to erase or overwrite files accidentally.

### Memory Card Slot Location

Memory Card Slot is located above USIM Card Slot. Do not insert Memory Card into USIM Card Slot.

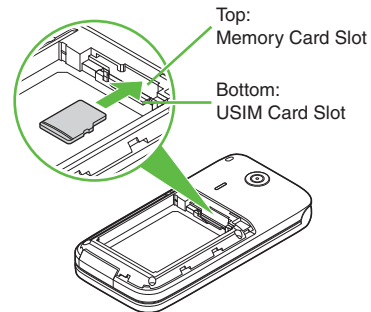

## Inserting & Removing

Power off first.

### 1 Remove Battery (P.1-3)

### 2 Insert Memory Card

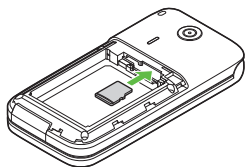

- Insert Memory Card (terminals facing down) all the way.
- Do not insert other objects.

### 3 Insert Battery, then replace Battery Cover (P.1-3)

#### If Appears after Power On

- Memory Card may not be inserted properly; reinsert it.

#### Removing Memory Card

- Gently push in Memory Card and release it; Memory Card pops out. Carefully remove Memory Card without bending it.

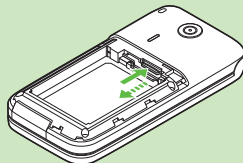



## Formatting Memory Card

When using a new Memory Card for the first time, format it on handset before trying to save files, etc. Formatting deletes all Memory Card files.

1  ➔ **Settings** ➔  ➔   
**Phone/** ➔ **Memory Card**  
 ➔ 

2 **Format Card** ➔  ➔ **Yes**  
 ➔ 

- Offline Mode activates. Handset transmissions are suspended until formatting is complete.

3 **Yes** ➔   
 • To cancel, choose **No** and press .

#### Precaution

- Never power off or remove Battery while files are being accessed.

## Text Entry

Unless noted otherwise, text entry descriptions are for text entry windows.

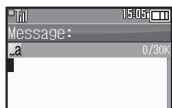

Text Entry Window (Message Text)

### Opening Help



### Note

- Pressing repeatedly may not close text entry windows.

### Switching Entry Modes

1

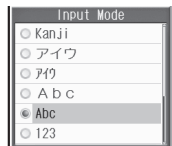

- Available entry modes appear.

2 Select mode

- Entry mode indicators:

	Kanji (Hiragana)
	Double/Single-byte Katakana
	Double-byte Alphanumerics (upper/lower case)
	Single-byte Alphanumerics (upper/lower case)
	Single-byte Number
	Character Code

appears when Predictive is active.

### Character Entry Basics

Use Keypad to enter characters. Multiple characters are assigned to each key. Press a key to toggle character options for that key.

**Example: In Double-byte Katakana mode, press three times.**



- Press to reverse-toggle options. To enter characters assigned to the same key, press first.

**Example: In Single-byte Alphanumerics mode, enter *no*.**



- Long Press a key to confirm the current character and advance cursor.





# Entering Characters

## Hiragana

Enter **すずぎ** in Kanji (Hiragana) mode.

- 1 (す) → →  
 (ず) → (ず) →  
 (ぎ)

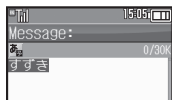

- 2 (Confirm)

## Kanji

Convert **すずぎ** to **鈴木**.

- 1 Enter **すずぎ**



- In Kanji (Hiragana) mode, word suggestions change as hiragana are entered. (Predictive)
- Long Press to toggle suggestion mode between Standard, Literary, Spoken and Automatic. (Personal Mode)

- 2

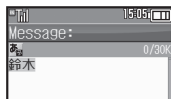

- 3 **鈴木**

- To exit suggestion list, press .

- 4



- Words likely to follow the entry appear. (Previous Usage)

### When Target Word is Not Listed

- Press or to segment hiragana to convert separately.
  - Press to toggle Predictive and Non-Predictive suggestions.

### Deleting Words/Phrases from Entry Log

- Enter hiragana → → Select word/phrase → (Long Press) → Yes →

## Entering from Dictionaries

Enter text by referring to word definitions, translations, etc.

### 1 Enter hiragana ➔ Before confirming entry,

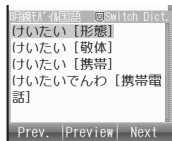

- Press  to toggle dictionaries.

### 2 Select word, etc. ➔

- Definition/translation appears.

### 3

## One-Hiragana Conversion

Enter the first hiragana for a suggestion list from previously selected words.

Example: **すずき** was previously converted to **鈴木**.

### 1 (ず) ➔

### 2 Select word/phrase ➔

## Correction Conversion

After mistyping hiragana assigned to the same key (e.g., **い** instead of **う**), enter intended word/phrase from suggestion list without retyping.

(Available when three or more hiragana are typed.)

### 1 Enter hiragana ➔ Before selecting word/phrase,

- Corrected word suggestions appear.

### 2 Select word/phrase ➔

## Katakana

Switch to Double-byte Katakana mode and enter **ジュン**.

### 1 ➔ **アイウ** ➔

### 2 (ジ) ➔ (ジ) ➔

### (ジ) ➔ (ユ) ➔

### (ン) ➔

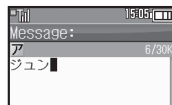

## Pictograms & Symbols



- May be unavailable depending on entry mode.
- Immediately after confirming a descriptive word such as **嬉しい** or **悲しい**, corresponding pictograms may appear in suggestion list. (PictogramWordLink)

### 1

- Pictogram or symbol list appears. (Log appears if pictogram/symbol has been used.)

### 2 (toggle tabs) ➔ or (toggle lists)



- While entering message text, press  in pictogram list to toggle cross-carrier pictograms and all pictograms. Alternatively, press  to switch to My Pictogram or symbol list.

### 3 Select pictogram or symbol ➔

- Pictograms are double-byte even in single-byte entry modes.

### 4 ➔ List closes

## Emoticons

1  ➔ **Emoticons** ➔ 

2 **Select emoticon** ➔ 

## Alternative Emoticon Entry Method

- In Kanji (Hiragana) mode, enter **かお** or a descriptive word such as **わーい** or **うーん**, then convert the entry.

## Mail &amp; Web Extensions

Enter **.co.jp**, **http://**, etc., easily.

1  ➔ **Quick Addr. List** ➔ 

2 **Select extension** ➔ 

- Extensions are single-byte even in double-byte entry modes.

Hiragana to Katakana/  
Alphanumeric Conversion

Enter katakana or alphanumerics in Kanji (Hiragana) mode using key inscriptions.

Example: Enter **PM**

1   ➔ 

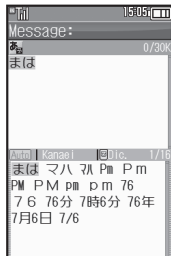

2 **Select word/phrase (PM)**  
➔ 

## Using Wildcard Characters



To improve word suggestions in Kanji (Hiragana) mode, or Single-byte Alphanumeric mode, add **\*s**, or **\*s** (wildcard characters) respectively, to entries. Use **\*** or **\*** to specify the character count: For example, enter **あか\*\*** for a list of words/phrases of four or more characters starting with **あか** or **あが**; enter **so\*\*** for a list of case-insensitive words/phrases that start with **so**.

Example: Kanji (Hiragana) mode

1 **Enter hiragana** ➔  ➔ 



- **\*** appears; to enter another **\***, press  again.

2  ➔ **Select word/phrase**  
➔ 

## Editing Characters

### Deleting & Editing

Correct **また、お願いします** to **また明日  
お願いします**.

#### 1 Select character

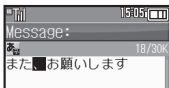

#### 2

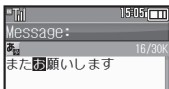

- Highlighted character is deleted.

#### 3 Select target location → Enter characters

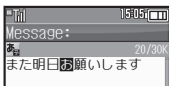

### Recovering Deleted Characters

- Press **[↶]** to recover characters deleted with **[↵]**.

### Deleting All Text

- Long Press **[↵]** at text end. To delete characters on and after cursor, select the first character of text and Long Press **[↵]**.

### Jumping to the End or Top of Text

- [↵]** → **Cursor Position** → **[↶]** → **Jump to End or Jump to Top** → **[↵]**

### Copy/Cut & Paste

#### 1 **[✂]** → **Cut or Copy** → **[↶]** → Select first character → **[↵]**

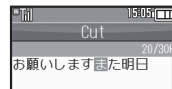

Cut

- To cancel and start over, press **[↵]**.

#### 2 Highlight text range → **[↶]**

#### 3 Select target location → (Long Press)

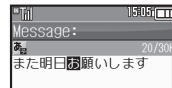

- Text is entered.

### Pasting Previously Cut/Copied Text

- Select target location → **[↶]** → **Paste** → **[↶]** → **Select text** → **[↵]**

- Available when Paste List appears.

# Customizing Fonts

## Enlarging All Fonts

Enlarge fonts for menus, text entry, etc.

- 1  (Long Press)

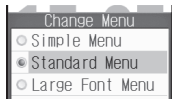

- 2 **Large Font Menu** →

Canceling Large Font Menu  
In , **Standard Menu** →

## Resizing Specific Fonts

- 1  → **Settings** →



- 2 In Sound/Display menu, **Display** →

- 3 **Font Settings** →

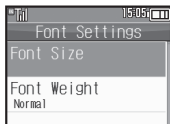

Font Settings Menu

- 4 **Font Size** →  → **Select item** →

- 5 **Select size** →

## Changing Font Weight

- 1 In Font Settings menu, **Font Weight** →



- 2 **Select weight** →

## Wallpaper

1 → **Settings** → → In **Sound/Display** menu, **Display** →

2 **Wallpaper** →

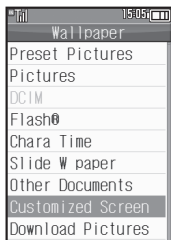

Wallpaper Menu

3 **Select folder** →

4 **Select file** →

- Some files may not be usable.
- Omit when **Preset Pictures** is selected in .
- Use to zoom in/out or press to rotate.

5

### Selecting Images Smaller or Larger than Display

After , select option → →

- For **Centered**, use to zoom in/out or press to rotate.

### Downloading Images from the Internet

In , **Download Pictures** →

- Read terms of service and then follow onscreen instructions.

### Selecting Images with Limited Usage Period

- Confirmation appears. Follow these steps:

**Yes** → →

### If Double Number Mode Menu Opens

**Select mode** →

### Selecting Chara Time Files

In , **Chara Time** → → **Select file**

→ → →

## Slideshow Wallpaper

Set slideshow to appear in Standby. Some folders/files may not be supported.

1 In **Wallpaper** menu, **Slide W paper** →

2 **Folder Setting** →

3 **Pictures or DCIM** →

4 **Select subfolder** → → **Set this folder** →

- Omit steps for subfolder if none is applicable.

### If There is No Image in Set Folder

- Preset images appear.

### Using Preset Images

In , **Preset Pictures** →

### Selecting Pattern

In , **Pattern Setting** → → **Select pattern** →

- To check patterns, select one and press .

## Customizing Handset Responses

### Ringtone

Use preset sounds or media files saved in Data Folder, etc.

- 1 **Settings** → **Sound/Display menu, Sounds & Alerts**



Sounds & Alerts Menu

- 2 **Ringtone/videos**
- 3 **Select item**  
For **For New Message**, etc., select **Assign Tone** and press.
- 4 **Select folder**
- 5 **Select tone/file**  
• Some files may not be usable.

### Changing Ringtone Duration

After **Duration** → **Enter time**

### Playing Video for Incoming Transmissions

In **Videos** →

### If Portion of File Content is Specifiable

- After, start point selection window opens. Follow these steps:

**Select start point**

### Selecting Files with Limited Usage Period

- Confirmation appears. Choose **Yes** and press to proceed.

### Machi-Uta® Service Registration (Japanese)

Use Machi-Uta® to play music instead of the standard ringback tone for the other party. Machi-Uta® requires a separate contract and basic monthly fee.

- 1 In **Sounds & Alerts menu, Machi-Uta**
- 2 **Register/Cancel**  
• Follow onscreen instructions.

### Vibration

- 1 In **Sounds & Alerts menu, Vibration**
- 2 **Select item** → **Switch On/Off**
- 3 **On**
- 4 **Vibration Pattern**  
• To check vibration patterns, select one and press.
- 5 **Select pattern**

### Important Vibration Usage Note

- Cancel Vibration when charging Battery to help avoid accidents.

## Emergency Calls

Your location is automatically reported to the corresponding agency (police, etc.) when you place emergency calls (110, 119 or 118) with SoftBank 3G handsets. (Emergency Location Report)

Handset reports Location Information based on positioning signals from radio stations.

- Registration/transmission fees do not apply.
- Positioning accuracy is affected by location/signal conditions. Always provide your location and purpose on the phone.
- Location Information is not reported when emergency calls are placed without Caller ID (such as when the number is prefixed with **184**). However, the corresponding agency may obtain your Location Information in a life threatening situation.
- Location Information is not reported during Global Roaming.

### Handset Restrictions & Emergency Calls

Emergency calls are possible even while some handset restrictions are active.

Active Restriction	Emergency Calls
Function Lock (in Locks)	Possible
Bar Outgoing Calls (in Call Barring)	
Offline Mode	Restricted
Keypad Lock	
PIN Entry (in Locks)	



## Voice Calling

### Answering a Voice Call

Incoming Call window opens for a call.

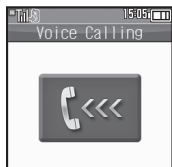

Incoming Voice Call Window

#### 1 to accept the call

- Call connects.

#### 2 → Call ends

#### Muting Ringer Temporarily

When a call arrives, 

#### Earpiece Volume



During a call, 

#### After Calls to/from Unsaved Numbers

- Save to Phone Book confirmation appears. Select **New Entry** or **New Detail** and press  to save number; Phone Book entry window or entry search window opens, respectively.

### Placing a Voice Call

#### 1 Enter number with area code

- To correct entry, use  to place cursor under the digit and press . To delete the digits above and after the cursor, Long Press .

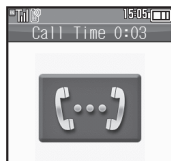

#### 2

- Wait for receiver to accept the call.



#### 3 → Call ends

#### Specifying Line when Double Number is set to Dual Mode

- After 1,  → **Select Line(Voice)** →  → **Select line** → 

### Placing an International Call

#### 1 Enter number with area code →



#### 2 Int'l Call →

#### 3 Select country → →

- Handset dials the number.

#### 4 → Call ends

#### Calling Unlisted Countries

- In , Enter Code →  → Enter country code → 

## Calling from Outside Japan

See below to place a call to Japan from abroad. Apply for Global Roaming beforehand. See SoftBank Mobile Website for details: [http://mb.softbank.jp/en/global\\_services/](http://mb.softbank.jp/en/global_services/) Access roaming area/rate information or print it out to carry with you while traveling abroad.

**1 Enter number with area code** ➔  ➔ **Int'l Call** ➔ 

**2 日本(JPN)** ➔  ➔ 

- Handset dials the number.
- To call other countries, select the target country instead of **日本(JPN)**.

**3**  ➔ **Call ends**

## Calling SoftBank Handsets

- In , always select **日本(JPN)**.

## Calling Landlines & Mobiles within the Same Country

Enter number with area code ➔ 

➔ **Dial to Your Stay** ➔ 

## Calls Overseas

- Calling may not be possible outside Japan. Connections depend on available network, signal strength, and handset settings.

## Improving Earpiece Sound Quality

Press  to activate Display first.

### Clear Talk

Use Clear Tone when the other party's voice sounds muffled. Cancel Slow Talk first.

**1 During a call,** 

- Audibility improves.
- To cancel, press  again.

### Slow Talk

Use Slow Talk when the other party's speech is too fast to follow. Cancel Clear Talk first.

**1 During a call,** 

- Speech slows down.
- To cancel, press  again.

## Video Calling

View the other party's image or send an Outgoing Image to compatible handsets. Handle Video Calls like Voice Calls. This page describes functions/operations unique to Video Call.

### Window Description

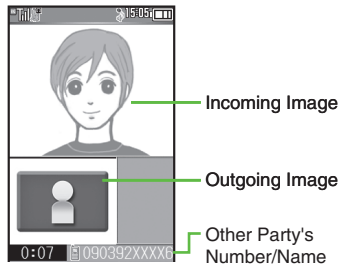

### Important Video Call Usage Notes

- If both parties are using handset models without internal cameras, Video Call cannot be used as intended.
- If both parties are not using the same Video Call system, call may be interrupted. (Video Call charges apply.)

### Answering a Video Call

Incoming call window opens for a call.



Incoming Video Call Window

- 1 **to accept the call**
  - Alternative Image is sent. (Video Call charges apply to the caller.)

- 2 **Call ends**

### Answering with Camera Image

[Incoming Video Call Window]

No

### Engaged Video Call Operations

Toggle View	
Toggle Outgoing Image	
Open Help	

### Placing a Video Call

- 1 **Enter number**
- 2 **Video Call**

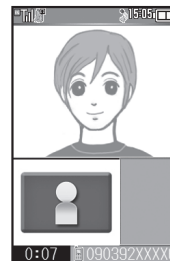

- Image appears when call is accepted.

- 3 **Call ends**

Specifying Line when Double Number is set to Dual Mode

After 1, **Select Line(Video)**

Select line

## Optional Services

Call Forwarding and Voicemail can only be set simultaneously when Call Forwarding is set to Video Calls.

<b>Call Forwarding</b>	Divert all/all unanswered calls to a preset number
<b>Voicemail</b>	Divert all/unanswered calls to Voicemail Center; access messages from handset/touchtone phones
<b>Call Waiting</b> *	Answer calls during a call
<b>Group Calling</b> *	Switch between open lines/connect multiple lines
<b>Caller ID</b>	Show or hide your number when placing calls
<b>Call Barring</b>	Restrict incoming/outgoing calls by conditions

\*A separate contract is required.

### Initiating Call Forwarding

Divert calls to a number saved in Phone Book after selected ring time (**No Answer** set).

(Numbers starting with 1, 00, 0120 or 0990 cannot be saved.)

1  → **Settings** →  →  → **Call**

2  **Voicemail/Call Forwarding** →

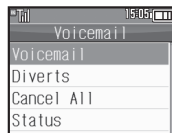

Voicemail Menu

3 **Diverts** →

4 **Select call type** →

5 **No Answer** →

6 **Phone Book** →  → **Select entry** →

7 **Select number** →

• Omit 7 if only one number is saved.

8

9 **Select ring time** →

**Diverting Calls without Handset Response**

In , **Always** →  →  -

**Entering Forwarding Number Directly**

In , **Enter Number** →  → **Enter**

number →  → **Select ring time** →

## Using Voicemail

Divert calls to Voicemail Center after selected ring time (**No Answer** set).

- 1 In Voicemail menu, **Voicemail** →  → **Activate** →
- 2 **No Answer** →  → **Select ring time** →

Diverting Calls without Handset Response  
In , **Always** →

## Missed Call Notification

Activate this function for records of calls missed when handset is off/out-of-range and Voicemail is active.

- 1  → **Settings** →  →  →
  - 2  **Missed Calls** →  →
- Follow the voice guidance.

## Playing Messages

- 1 In Voicemail menu, **Voicemail** →
  - 2 **Play Voicemail** →
- Follow the voice guidance.

Deleting New Voicemail Message Indicator  
In , **Clear Indicator** →  → **Yes** →

## Canceling Call Forwarding/Voicemail

- 1 In Voicemail menu, **Cancel All** →
- 2 **Yes** →

## Creating Phone Book Entries

Enter a name, phone number and mail address (enter at least one of these items) and classify the entry.

**1** **Phone** **Add New Entry**



**2** **Last Name:** **Enter last name** **First Name:** **Enter first name**



- Characters entered for names (reading for kanji) appear.

**3** **Add Phone Number:** **Enter number** **Select type**



- To save additional numbers, repeat **3**.

**4** **Add Email Address:** **Enter mail address** **Select type**

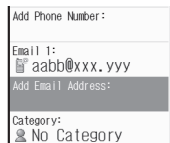

- To save additional mail addresses, repeat **4**.

**5** **Category:** **Select Category**

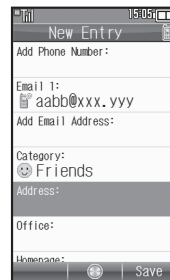

Phone Book Entry Window

**6** **Entry is saved to Phone Book.**

**Incoming Calls while Creating Entry**  
 • Content remains. End the call to return.  
**Selecting Mode when Double Number is set to Dual Mode**

**[Phone Book Entry Window] Mode:**  
**Select mode** **6**

### Personal Ringtone

Set tone for calls from saved numbers.

- 1 In Phone Book entry window, select item, e.g., *Tone-Voice Call*: ➔
- 2 *Assign Tone* ➔ ➔ Select folder ➔
- 3 Select tone/file ➔ ➔

### Saving Secret Entries

Hide Phone Book entries; access requires Handset Code entry.

- 1 In Phone Book entry window, *Secret*: ➔
- 2 *On* ➔ ➔

### Accessing Secret Entries

- ➔ ➔ *Unlock Temporarily* ➔   
➔ Enter Handset Code ➔

### Customizing Response by Category

- 1 ➔ *Phone* ➔ ➔ *Set Category* ➔



- 2 *Select Category* ➔ ➔ *Select item* ➔
- 3 *Select item* ➔ ➔ *Select item, e.g., Assign Tone* ➔ ➔ *Customize responses*
  - Customize responses in the same way as Phone Book entries.
  - Not available for USIM Card.

### Responses Set by Phone Book Entry

- Settings for each entry take priority.

### Saving Numbers After Calls

After a call, save number to Phone Book.



- 1 When confirmation appears, *New Entry* ➔ ➔ *Complete fields* ➔

### Saving to an Existing Entry

- In 1, *New Detail* ➔ ➔ *Select entry* ➔ ➔ *Complete fields* ➔

## Using Phone Book Entries

### Dialing from Phone Book

- 1 ➔ **Select tab (hiragana row, alphabet or \*) for first character of last name**



Entry Search Window (By あかさたな)

- When Double Number is set to Dual Mode, line indicators appear.

- 2 **Select entry** ➔
- 3 **Select number**
- 4

#### Placing Video Calls

After ➔ **Video Call** ➔

### Changing Search Method

Phone Book search methods:

By あかさたな	Shows entries by tab; entries are sorted by Reading of last name
By Category	Opens entries in the specified Category
By Reading	Shows all entries in Reading order (katakana, alphabetical then numerical)

- 1 **In entry search window,** ➔ **Ph.Book Settings** ➔
- 2 **Sort Entries** ➔
- 3 **Select method** ➔

Changing Search Method Temporarily  
[Entry Search Window] (press to toggle search methods)

### Opening from Other Functions

Example: Enter a recipient from Phone Book when sending a message.

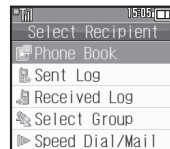

Select Recipient Window

- 1 **Phone Book** ➔
- Entry search window opens.
- 2 **Select entry** ➔
- 3 **Select number or mail address** ➔
  - Recipient is entered.
  - Omit if only one number or address is saved.



## Customizing Handset Address

Change alphanumerics before @ of the default handset mail address.

For more information, contact SoftBank Customer Support, General Information (P.9-1).

### Changing Address

1  ➔ **Settings** ➔ 

2 **Address Settings** ➔ 

- Handset connects to the Internet.  
Select **English** and press , then follow onscreen instructions.

### Saving Address

When handset address is changed, SoftBank Mobile sends new address confirmation to handset.

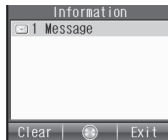

To save new address to My Details:  
(New address is effective even if not saved.)

1 **Message** ➔ 



2 **Information** ➔ 

3 **Yes** ➔ 



4 

## Sending S! Mail

Send S! Mail to a number/address saved in Phone Book.

- 1 ➔ **Create Message** ➔   
 When a PC Mail Account exists, select **S! Mail** and press .

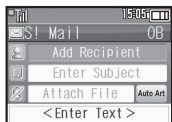

S! Mail Composition Window

- 2 **Select Recipient field** ➔
- 3 **Phone Book** ➔
- 4 **Select entry** ➔
- 5 **Select number or mail address** ➔

- Omit if only one number or address is saved.
- When a mail address is entered, avoid using single-byte katakana in message text or subject; may not appear properly on recipient devices.

- 6 **Select Subject field** ➔ ➔   
 **Enter subject** ➔

- 7 **Select Message Text field** ➔

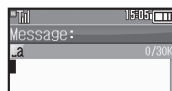

Text Entry Window

- 8 **Enter message** ➔



S! Mail Composition Window

- 9 ➔ **Transmission starts**   
 • To cancel, press .

### Incoming Calls while Creating Message

- Content remains. End the call to return.
- ### Personal Mode
- When recipient is entered from Phone Book, text entry window word suggestions change by recipient type.

### Previewing Outgoing Message

- After , ➔ **Preview Message** ➔

### Pictogram Entry

- In pictogram list, press to toggle cross-carrier pictograms and all pictograms.
- Pictogram appearance may differ by carrier.

### Specifying Line when Double Number is set to Dual Mode

- [S! Mail Composition Window] ➔ **Switch Line** ➔ ➔ **Select line** ➔

### Converting to Graphic Mail

- After , **Auto Art** ➔ ➔ **Select decoration type** ➔ ➔ (Next) or (Prev.) ➔ ➔

- To cancel conversion (before ): ➔ **Cancel Arrangement** ➔ ➔ **Yes** ➔

## Attaching Files

Send images to compatible handsets using S! Mail.

**1** In S! Mail Composition window after composing message, select Attachment field ➔ 

**2** *Picture* ➔  ➔ Select folder ➔ 

**3** Select file ➔ 









File attached

**4**  ➔ Transmission starts

## Attaching Non-Image Files

- In **2**, select a folder other than *Picture* and press , then select a file.

## Attaching Multiple Files

After **3**, *Attach (1)* ➔  ➔ *Attach File* ➔  ➔ *Picture* ➔  ➔ *Select folder* ➔  ➔ *Select file* ➔  ➔ 

- *X* in *Attach (X)* indicates the number of attached files.

## Automatic Image Resizing

Large images may be automatically reduced to approximately 400 - 500 KB by default. Change resize setting with Picture Auto Resize in Create/Send Settings.

## If Recipient Cannot Receive Large Messages (Up to 2 MB)

- Message may be truncated or attachments may be lost.

## Sending SMS

Send SMS to a number saved in Phone Book.

1  ➔ **Create New SMS** ➔ 

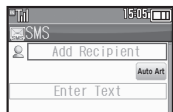

SMS Composition Window

2 **Select Recipient field** ➔ 

3 **Phone Book** ➔ 

4 **Select entry** ➔ 

5 **Select number** ➔ 

- Omit  if only one number is saved.

6 **Select Message Text field**



Text Entry Window

7 **Enter message** ➔ 

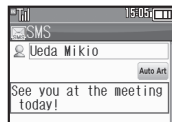

SMS Composition Window

8  ➔ **Transmission starts**

### Incoming Calls while Creating Message

- Content remains. End the call to return.

### Personal Mode

- When recipient is entered from Phone Book, text entry window word suggestions change by recipient type.

### When Message Text Exceeds Limit

- Confirmation appears. To convert SMS to S! Mail, choose **Yes** and press .

**Specifying Line when Double Number is set to Dual Mode**

[SMS Composition Window]  ➔ **Switch Line** ➔  ➔ **Select line** ➔ 

### Entering Pictograms Automatically

After , **Auto Art** ➔  ➔  (Next) or  (Prev.) ➔  ➔ 

## Customizing Message Retrieval

Set manual retrieval (only initial portion of message text first received, no attachments) or automatic retrieval for specific mail (by sender type, mail address, etc.).

### Retrieving Messages Manually

- 1  → **Settings** →
- 2 **Receive Settings** →
- 3 **Message Download** →

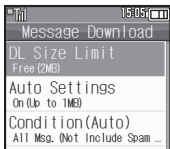

Message Download Menu

- 4 **Auto Settings** →

- 5 **Off** →

**Retrieving Complete Messages Automatically when Approximate Size is 300 KB or Less**

In  **On (Up to 300KB)** →

### Specifying Automatic Retrieval

#### By Sender Type

- 1 In Message Download menu, **Condition (Auto)** →

- 2 **Selected Mail** → 

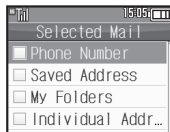

Selected Mail Menu

- 3 **Select item** →  (/) → 

#### By Mail Address





Specify mail addresses or domains (alphanumerics after @ of mail addresses).

- 1 In Selected Mail menu, **Individual Address** → 
- 2 **Select blank entry** →
- 3 **Select method** →  → **Select/enter address** → 
  - Repeat 2 - 3 to add mail addresses.

- 4 

- 5  () → 

#### Specifying by Domain (Direct Entry)

[Selected Mail Menu] **Receive by the Domain** →  → **Select blank entry** →  → **Direct Entry** →  → **Enter domain** →  →  →  → 

## Managing & Using Messages

### Messaging Folders

Messages are organized in folders by type.

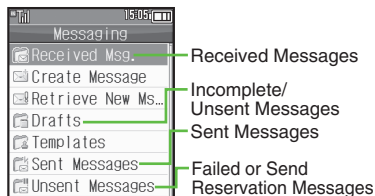

### Automatic Message Deletion

- Handset automatically deletes oldest received/sent messages to save new ones if corresponding folder is full.
- Protect important messages to avoid unintentional deletion.

### Opening Help

- In folder list, message list or message window:

→ **Help** →

### When Failed Message is Saved

- A reminder message appears upon opening Messaging menu.

### Opening Messages

- **Received Msg. or Sent Messages** →

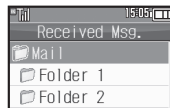

Folder List

- When a PC Mail Account exists, PC Mail folder (folder with the name specified in Account Name) appears.
- Select Mail folder or PC Mail folder and press to hide/show subfolders. To open full message list, hide subfolders and press .

- Select folder** →



Message List

- Select message** →



Message Window

### Protecting Messages

- In message list, select message** → → **Manage Msg.** →

- Lock** →

### Canceling Protection

In , **Unlock** →

## Window Description

## Message List

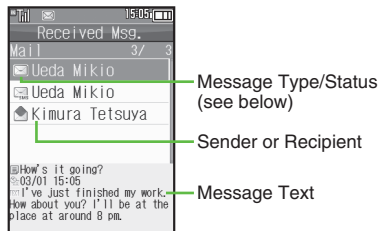

## Message Type/Status

	Unread		Mail Notice (remaining portion exists)
	Read		Unread Delivery Report
	Sent		Attachments
	Failed		Protected
	Replied		Priority (High)
	Forwarded		Priority (Low)
	Send Reservation set		USIM Card SMS

SMS or PC appears accordingly on indicators.

## Message Window

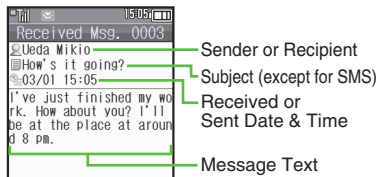

Press **[\* 3]** or **[# 3]** to open other messages (higher or lower in message list).

## Changing Font Size

**[Message Window] [3.] (Long Press) to enlarge or [1.] (Long Press) to reduce**

## PC Mail

Receive or reply to PC mail account messages.

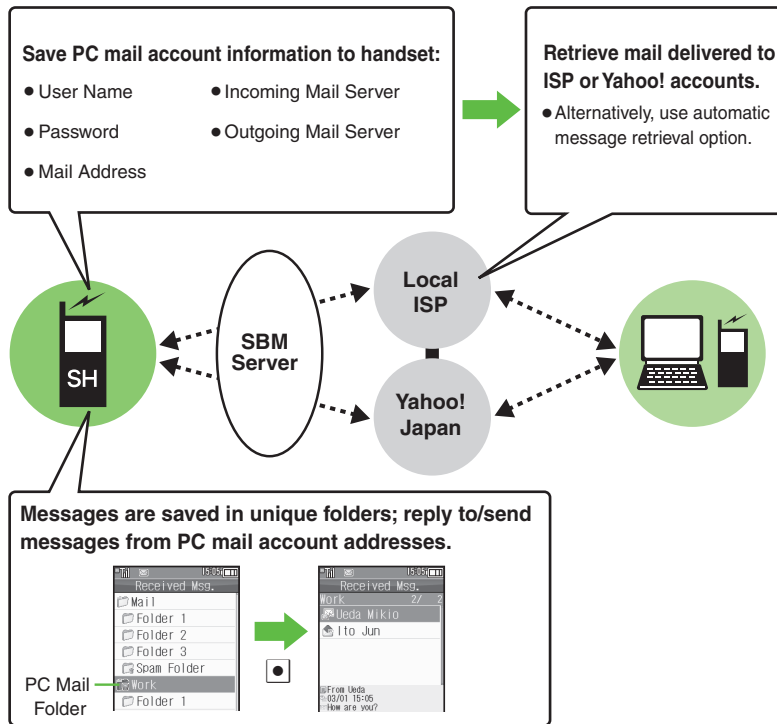

### Important PC Mail Usage Notes

- Receiving PC Mail for the first time after PC Mail Account setup may incur high charges due to large-volume packet transmissions.
- Setting handset to retrieve PC Mail automatically may incur high packet transmission fees. Take special care when using handset outside Japan.
- Other functions may slow while handset is checking for new messages.
- Checking for new messages may incur packet transmission fees even when none exists.
- Single-byte katakana and pictograms are not supported.
- When messages sent from a mobile phone to PC mail account are retrieved by handset (then opened, replied with quotes, forwarded, etc.), included pictograms may not appear or may appear as different characters.



## PC Mail Account Setup

- Proceed with setup according to information supplied by ISP.
- PC Mail services may be unavailable depending on the services, settings or contract details for your PC mail account. Confirm compatibility with POP/SMTP message retrieval/transmission from e-mail client beforehand.

### Mandatory Items for Retrieval

<b>User Name</b>	Required to connect to incoming mail server
<b>Password</b>	Required to connect to incoming mail server
<b>ReceivingServer</b>	Incoming mail server address

### Mandatory Items for Transmission

<b>Mail Address</b>	Address to use PC Mail
<b>Sender Server</b>	Outgoing mail server address

### Setting Other Items

- Edit information as needed; for description, select an item and press .



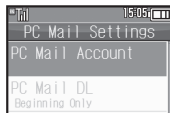

- 1  ➔ **Settings** ➔  ➔ **PC Mail Settings** ➔ 



- 2 **PC Mail Account** ➔ 

- 3 **<Empty>** ➔ 

- 4 **Account Name** ➔  ➔ **Enter name** ➔ 

- 5 **Set Receiving** ➔  ➔ **Select item** ➔  ➔ **Select/enter item** ➔  ➔ 

- User Name, Password and ReceivingServer are mandatory.



- 6 **Set Sending** ➔  ➔ **Select item** ➔  ➔ **Select/enter item** ➔ 

- Mail Address and Sender Server are mandatory.

- 7  ➔  ➔ 

- If confirmation appears, follow onscreen prompts.

## Using Yahoo! Mail Addresses



- In , **Set Quick Yahoo! Mail** ➔  ➔ **Yes or No** ➔ 

- Follow onscreen instructions.
- Choose **No** to create a new account.

### Editing Accounts











- In , **select account** ➔  ➔ **From** 

### Deleting Accounts

- In , **select account** ➔  ➔ **Yes** ➔ 

### Saving User ID & Password for Transmission

- If User Name and Password are unset Set Receiving items are automatically used for SMTP authentication. Follow these steps if ISP requires User Name and Password:

- In , **Set Sending** ➔  ➔ **Sender Auth.** ➔  ➔ **SMTP Auth.** ➔  ➔ **User Name** ➔  ➔ **Enter name** ➔  ➔ **Password** ➔  ➔ **Enter password** ➔  ➔  ➔  ➔ 

## Retrieving New PC Mail

Retrieve new messages from created accounts. If message count is high, some may not be received on the first attempt.



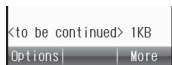

- 1  ➔ 
- 2 
- 3 **Select PC Mail folder** ➔   
➔ **Select message** ➔ 





Message Window

- Press  to retrieve full message.
- Message window is similar to that of S! Mail.

### Deleting Messages





- [Message List] **Select message** ➔   
➔ **Delete** ➔  ➔ **Select option** ➔  
 ➔ **Yes** ➔ 

### Retrieving Messages by Account

- After 1, **select account** ➔  ➔   
■ Omit  if only one message is retrieved.



## Sending PC Mail

To create and send PC Mail:

- 1  ➔ **Create Message** ➔ 
- 2 **Select PC Mail Account** ➔ 
- 3 **Complete message** ➔  ➔  
**Transmission starts**

### Converting to S! Mail

After ,  ➔ **Convert to S! Mail** ➔

 ➔ **Yes** ➔ 

### Note

- Single-byte katakana and pictograms are not supported.

## Service Basics

Access the Mobile Internet from Yahoo! Keitai, or view PC Internet sites from PC Site Browser.

- Service requires a separate contract; retrieve Network Information to use these services.
- For more about Yahoo! Keitai, see SoftBank Mobile Website (P.9-1).

### Transmission/Information Fees

Some page content may automatically activate Internet connection incurring transmission fees. (Information fees may also apply.) To prevent automatic connection, select an appropriate option for **Script Settings**, **Flash® auto-download** and **Download Videos** in Security Settings (e.g., in Browser Settings for Yahoo! Keitai).

### Security

Electronic certificates are saved on handset to support SSL/TLS (encryption protocol for Internet transmissions of important/sensitive information).

### Opening Secure Pages

- Confirmation appears. Choose **Yes** and press  to proceed.
- When a security notice appears upon opening an Internet page, subscribers must decide for themselves whether or not to open the page. Opening secure pages constitutes agreement to the terms of SSL/TLS usage. SoftBank, SHARP Corporation, VeriSign Japan, Cybertrust, Entrust Japan, GMO GlobalSign, RSA Security, SECOM Trust Systems, Comodo Japan and J Cert, Inc. cannot be held liable for any damages associated with the use of SSL/TLS.

## Using Yahoo! Keitai

### Using Yahoo! Keitai Main Menu

Browse Yahoo! Keitai sites from Yahoo! Keitai Main Menu.

Internet pages may not open depending on connection/server status, etc.

#### 1 [Internet Page] → Connection starts

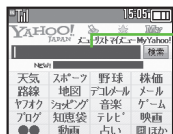

Cursor

Internet Page

- Yahoo! Keitai Main Menu opens.
- To disconnect, press [Internet Page].

#### 2 [Internet Page] → Highlight menu item → [Enter]

- Corresponding page opens.
- Repeat 2 to open additional links.

#### 3 [Internet Page] → Yes → [Enter] → Page closes

### Returning to Previous Pages

[Internet Page] [Internet Page] → Previous page opens

- To return to the initial page:

[Internet Page] [Internet Page] → Forward → [Enter]

Returning to Yahoo! Keitai Main Menu

[Internet Page] [Internet Page] → Yahoo! Keitai → [Enter]

### User Authentication

• To open pages requiring authentication:  
Enter user ID or password → [Enter] → [Enter]

### Accessing メニューリスト Directly

[Enter] → Yahoo! → [Enter] → Menu List → [Enter]

- メニューリスト is a portal to Yahoo! Keitai content and services. (Includes a link to lists of sites supporting English.)

### Using History

1 [Internet Page] → Yahoo! → [Enter] → History → [Enter]

2 Select record → [Enter] → Connection starts

- Corresponding page opens.

3 [Internet Page] → Yes → [Enter] → Page closes

### Entering URLs Directly

1 [Internet Page] → Yahoo! → [Enter] → Enter URL → [Enter]

2 Enter URL → [Enter] → Connection starts

- Corresponding page opens.

3 [Internet Page] → Yes → [Enter] → Page closes

## Browsing PC Sites

View PC Internet sites from PC Site Browser.

- Internet pages may not open depending on connection/server status, etc.
- Browsing PC sites may incur high charges depending on subscribed price plan.

1  → **Yahoo!** →  → **PC Site Browser** → 

2 **Homepage** →  → **Connection starts**

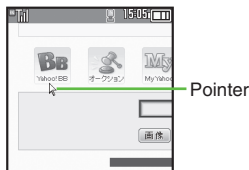



Internet Page

- Yahoo! JAPAN Home opens.
- If a message appears, follow onscreen prompts.
- To disconnect, press .

3 **Highlight menu item** → 

- Corresponding page opens.
- Repeat  to open additional links.

4  → **Yes** →  → **Page closes**

### Returning to Previous Pages

[Internet Page]  → Previous page opens

- To return to the initial page:

[Internet Page]  → **Forward** → 

### Returning to Yahoo! JAPAN Home

[Internet Page]  → **Homepage** → 



### User Authentication

Enter user ID or password →  → 





### Using History

In , **History** →  → **Select record** → 

### Entering URLs Directly

In , **Enter URL** →  → **Enter URL** → 

### Hiding Softkeys

[Internet Page]  → **Convenient Functions** →  → **Softkey Area** →  → **Off** → 

### Browsing in Wideview

[Internet Page]  ■ Use Multi Selector according to page orientation.

## Basic Operations

### Page Browsing

#### Scrolling Pages

If page content continues beyond view, use to scroll pages.

Long Press to scroll continuously.

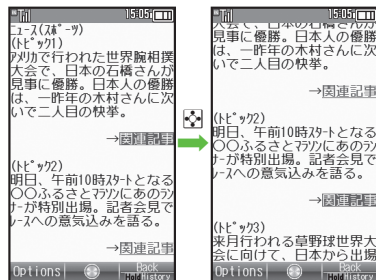

### Switching Frames

On framed pages, Long Press to switch active frame.

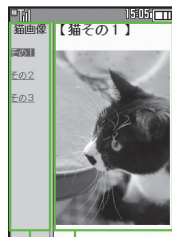

Frames

- In pointer navigation, point to a frame and press to select it.
- Otherwise, use to select one.

#### Viewing Single Frame

[Internet Page] Select frame

Convenient Functions

Frame In

- To return, press .

### Tabbed Browsing

Open another page in a new tab and switch between tabs.

#### Opening a New Tab

1 On a page, select menu item

**Tab Menu**

2 Open in New Tab

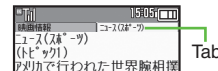

#### Switching Tabs

1 (Long Press)

Select tab

- In pointer navigation, point to a tab and press to open it.

#### Closing Tabs

(Long Press) Select tab

**Tab Menu**

**Tab or Close All Other Tabs**

## Selecting Text

Activate Drag Mode in pointer navigation to enable text selection. Select text to copy or look up words in dictionaries.

To use a dictionary:

(Text may not be selectable or linked page may open depending on site or page.)

### 1 On a page, point to first character ➡ (Long Press)

- Drag Mode activates.

### 2 Highlight text range

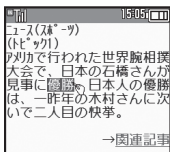

### 3

### 4 ➡ Select dictionary



- Dictionary opens with text inserted.

### 5 Search ➡ ➡ Select word, etc. ➡

## Starting Over

- After , point to first character ➡   
➡ From

## Additional Page Operations

Enter text or select/execute items.

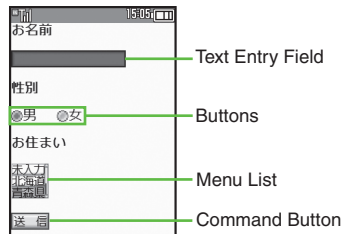

## Text Entry

### 1 On a page, select text entry field ➡

### 2 Enter text ➡

- Internet page returns.

## Using Entered Text (Input Memory)

- [Internet page] Select text entry field  
➡  ➡  ➡ Insert/Font Size ➡   
➡ Input Memory ➡  ➡ Select text  
➡

## Pull-down Menu Item Selection

### 1 On a page, select menu list field ➡

### 2 Select item ➡

## When Multiple Items are Selectable

- Select items as needed and press .

## Page Item Indicators

### ■ Selection Items

Buttons  or boxes  appear.

### 1 On a page, select button or box ➡



- /  changes to / .

### ■ Execution Items

Execute the assigned command.

### 1 On a page, select command ➡

## Infrared

Wirelessly transfer files between handset and compatible devices.

### Transferable Files

Phone Book	Received Msg.
Calendar	Sent Messages
Tasks	Drafts
Notepad	Templates (Messaging)
Bookmarks	Data Folder

- Copy/forward-protected files are not transferable.
- Some files may not be transferable; some settings may be lost, or files may not be saved properly.

### Getting Started

#### Infrared Precautions

Align Infrared Ports of both devices.

- Handset cannot receive connection requests during Software Update.

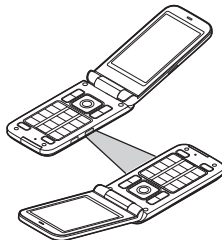

- Do not place objects between devices.
- Keep Infrared Ports aligned during transfer.
- Do not look into Infrared Port during Infrared transmissions. Eyesight may be affected.
- SoftBank 105SH complies with IrMC 1.1; however, some files may not transfer properly.

### Transfer Options

<b>One File Transfer</b>	Transfer single files
<b>All File Transfer</b>	Transfer all files by function

- Some transfer options may be unavailable depending on file type.
- Transfer Memory Card files one by one.

#### Authorization Code

- Four-digit code required for Infrared transfers. All File Transfers are possible when codes match. (Authorization Code is changeable for each transfer.)



# Transferring Files Using Infrared

## Receiving Files

### 1 (Long Press)



- Infrared activates. (Alternatively, activate it from Main Menu.)
- Handset receives files if sent within three minutes.
- Handset must be in Standby to accept connection requests.
- To cancel Infrared, Long Press .

### 2 Connection request arrives

### 3 Perform subsequent operations

- To cancel transfer, press .

## Subsequent Operations

### ■ One File Transfer

Yes  

- If storage media confirmation appears, select media and press .

### ■ All File Transfer (Adding Files)

Yes    Enter Authorization

Code    As New Items  

### ■ All File Transfer (Overwriting Existing Files)

Yes    Enter Authorization

Code    Delete All & Save 

  Yes  

- For Phone Book, My Details except handset number is overwritten as well.

## Sending Files

### ■ One File Transfer

Example: Phone Book entry

1   Select entry    Send Entry  

2 Via Infrared    Transfer starts

- When complete, entry search window returns.

## All File Transfer

1   Tools     Connectivity  Infrared  



2 Send All  

3 Yes    Enter Handset Code  

4 Select item   ( / )  Complete selection  

5 Enter Authorization Code    Transfer starts  

### Sending Phone Book

- In , Picture transfer confirmation appears; choose **Yes** or **No** and press .

## Exchanging Contact Information

Exchange name, phone numbers, mail addresses, and other contact info with other compatible handsets using Infrared. Read **P.6-1** "Infrared Precautions" beforehand.

### Receiving Profiles

#### 1 (Long Press)

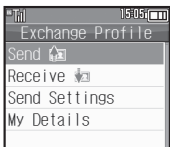

Exchange Profile Menu

#### 2 **Receive**

#### 3 **Profile received**

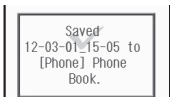

- Received profile is saved to Phone Book.

### Sending Profiles

#### 1 **In Exchange Profile menu,** **Send** **Transfer starts**

#### Changing Profile Items to Send

[Exchange Profile Menu] **Send**

**Settings**    **Select item**  

(/)  **Complete selection**  

#### Opening My Details

[Exchange Profile Menu] **My Details**

## Connecting PC

### Accessing Memory Card

Connect handset to a PC with USB Cable to access Memory Card from the PC without removing it from handset.

USB Cable may be purchased separately.

#### 1 Connect handset to a PC with USB Cable

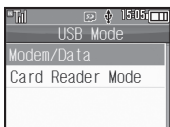

#### 2 Card Reader Mode ➔

- Use PC to access Memory Card.

#### 3 ➔ Yes ➔ ➔

#### Connection ends

- Disconnect USB Cable.

#### If Menu in 1 Does Not Appear

➔ Tools ➔  ➔  Connectivity  
➔ From 2

- Operations on the PC may be required; if prompted, follow onscreen instructions.

### Utility Software (Japanese)

For more PC-related operations, download Utility Software (including USB Cable driver) from the following URL.

#### Utility Software

[http://k-tai.sharp.co.jp/support/download/s/#!/soft\\_utility](http://k-tai.sharp.co.jp/support/download/s/#!/soft_utility)

#### Mobile Data Communication Fees

- Accessing the Internet from handset using a PC/PDA may incur high charges as large-volume packet transmissions tend to occur in a short period of time.

## Basics

Back up information to Memory Card, and restore to handset as needed.

Specify frequency for Auto Backup.

Auto Backup requires a subscription to S! Addressbook Back-up.

### Supported Items

Select items, or back up all items together at once.

In Manual Backup, open Options menu for **Check Selection** to select multiple items for simultaneous backup.

Phone Book*	Sent Messages*
Calendar*	Drafts*
Tasks*	Templates (Messaging)
Bookmarks*	Contents Keys
Notepad*	Data Folder
Mail Groups*	User Dictionary
Received Msg.*	

\*Selectable for simultaneous backup.

### Auto Backup Compatibility

- These items are not backed up:
  - Mail Groups
  - Templates (Messaging)
  - Data Folder
  - User Dictionary

### Precautions

- Not available if Battery is low.
- Backup may fail if Memory Card memory is low.
- Some items may not be transferable; some settings may be lost, or files may not transfer properly.

### Auto Backup File Deletion

- Auto Backup saves up to three backup files for each item; when full, handset automatically deletes oldest files to save new ones.

### Contents Keys

- Manual Backup overwrites Contents Keys in Memory Card. Perform Restore beforehand to keep previous Keys.
- In Auto Backup, Contents Keys are added to Memory Card.

### Restoring Backed Up Content

- Corresponding handset content is overwritten depending on Restore option.

# Backup & Restore

## Manual Backup

To back up selected items together at once:

- 1  → **Settings** →  →   
**Phone/** → **Backup/**  
**Restore** →



Backup/Restore Menu

- 2 **Backup Selected Items** →  
 → **Enter Handset Code**  
→
- 3 **Yes** →
- 4 **Select item** →  (/✓) →  
**Complete selection**
  - For **Phone Book**, confirmation appears. Choose **Yes** or **No** and press .

- 5  → **Yes** → 
  - To cancel, press .

- 6 **Backup complete** →  →

### Selecting Multiple Items Together at Once

In 4,  → **Select option** →  →

From 5

### Selecting/Canceling All Items

In 4,  → **Check All or Uncheck All**

→

## Auto Backup

Back up information to Memory Card at a specified frequency automatically.

To enable Auto Backup, set Auto Sync Settings (S! Addressbook Back-up) to **On**; Auto Backup will be performed at 2:00 AM on the same day of the week by default.

### Precautions

- Auto Backup does not start when:
  - Memory Card is not inserted
  - Battery is low/dead and not being charged
  - Another function is active (end it and return to Standby to start backup)

### At Auto Backup Time

Backup starts; Information window opens upon completion.

Select **Complete Auto Save** and press  to open backup result.

## Changing Settings

To back up once a week automatically:

- 1 In Backup/Restore menu, **Settings/Manage** →
- 2 **Auto Backup** →  → Enter Handset Code →



Auto Backup Menu

- 3 **Frequency Settings** →
- 4 **Once Every Week** →  → Select day →  → Enter time →
- 5 **Backup Items** →  → Select item (/) → Complete selection →

## Backing Up Once a Month

- In 4, **Once Every Month** →  → Enter date →  → Enter time →  → 5

## Disabling Auto Backup

- In 4, **Don't Auto Backup** →
- Disabling Encoding  
[Auto Backup Menu] **Encode Settings** →  → **Off** →

## Memory Card to Handset

To restore selected items:

- 1 In Backup/Restore menu, **Restore Selected Items** →  → **Yes** →
- 2 Select item →  (/) → Complete selection
- 3 
  - If no file list appears, skip ahead to 5.
- 4 **Select file** → 
  - Repeat 4 to complete selection.

5

6 **Yes** →

- To cancel, press .

7 **Restore complete** →  →

## Selecting Multiple Items Together at Once

- In 2,  → Select option →  → From 3

## Selecting/Canceling All Items

- In 2,  → **Check All or Uncheck All** →

## Changing Restoration Method

- After 2, select item →  → **Change to Add Mode or Chg. to Overwrite Mode** →  → From 3

## Getting Started

Capture photos or record video.

### Various Sizes

Select small sizes to send captured photos/recorded video using S! Mail<sup>®</sup>; select larger sizes for higher resolutions.

### Auto Focus

Measures the distance between subjects and Camera to adjust focus.

### Shooting Modes

Apply effect or add frame, or capture successive photos.

### Review

Open/play last saved Camera file quickly; access older files as needed.

\*May not be delivered as sent depending on shooting size or recipient device.

### Important Camera Usage Notes

- Clean dust/smudges from Lens Cover with soft dry cloth before use.
- Camera is a precision instrument; however, some pixels may remain on/off.
- Shooting/saving images while handset is hot may affect the image quality.
- Exposing Lens to direct sunlight may damage Color Filter and affect image color.

### Automatic Shutdown

- Camera shuts down after a period of inactivity and handset returns to Standby.

### Shutter Click

- Shutter click and Self-timer tone sound at fixed volume regardless of handset settings.

## Capturing Photos

1  (Long Press)

2 Frame subject on Display



Photo Viewfinder

3 

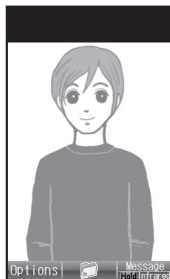



Captured Photo Window

- Shutter clicks and photo is captured.  
(To start over, press .)





4 

- Photo is saved. (Viewfinder returns.)
- Open saved photos from Review or Data Folder.

5  ➔ **Camera shuts down**

**Sending Captured Photos Using S! Mail**  
 [Captured Photo Window]  ➔  
 Complete message ➔ 

### Main Viewfinder Operations

Zoom In/Out*	
Toggle Camera	
Adjust Brightness	
Change Shooting Size	
Open Help	

\*May be unavailable depending on shooting size.



## Recording Video

### 1 (Long Press)

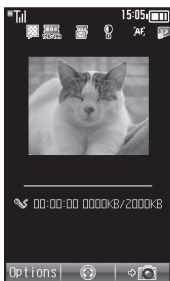

Video Viewfinder

### 2 **Frame subject on Display**

- Tone sounds and recording starts.  
(To start over, press .)

### 3

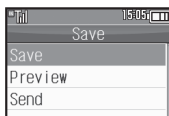

Video Save Menu









- Tone sounds and recording stops.  
(To start over, press .)

### 4 **Save**

- Video is saved. (Viewfinder returns.)
- Play saved video from Review, Data Folder or Media Player.

### 5 **Camera shuts down**

#### ■ Main Viewfinder Operations

Zoom In/Out	 / 
Toggle Camera	
Adjust Brightness	 / 
Change Shooting Size	 
Open Help	

#### Playing Unsaved Video

In 4, **Preview** 

#### Sending Recorded Video Using S! Mail

In 4, **Send**   **Save and Send**

  **Complete message** 

- May not be delivered as sent depending on shooting size or recipient device.

#### Incoming Calls while Recording

- Recorded clip remains even if the call is answered. End the call to save it, etc.

#### If Battery Runs Low

- Recording stops. (Recorded clip is saved.)

## Opening Saved Files

### Opening Last Saved File

Open/play last saved Camera file; access older files as needed.

1 [OK] → **Camera** → [OK]

2 **Review** → [OK]



Review Window

- To end, press [ESC].

### Enlarging Photos

After [OK], [OK]

### Pausing/Resuming Video

After [OK], [OK] (press to pause/resume)

### Opening Help

[Review Window] [0?]

### Accessing Older Files

1 In Review window, [v]

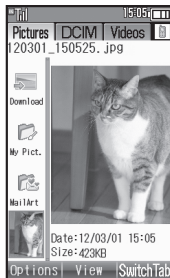

Review File List

- File list appears.
- Press [v] to toggle lists.





2 **Select file** → [OK]

- File opens/plays.

## Using Shooting Modes

May be unavailable depending on selected shooting size.

### Self-timer

- In Photo/Video Viewfinder,**  
 ➔ **Self-timer** ➔ 
- Select time** ➔ 
- Frame subject on Display**  
 ➔ 
  - After selected time elapses, photo is captured or recording starts.
  - To stop recording, press .
  - For more, see operation descriptions on P.7-2 or P.7-3.

Releasing Shutter during Countdown  
 After ,

Incoming Calls/Alarm during Countdown  
 • Countdown stops. (Self-timer remains active.)

### Continuous Shoot (Photo Camera)





Available modes:

4 Pictures	Capture four separate photos with index image
9 Pictures	Capture nine separate photos with index image
Overlapped	Capture five photos to create a composite image

- In Photo Viewfinder,**  ➔ **Modes** ➔ 



Mode Menu

- Continuous Shoot** ➔ 
- Select mode** ➔  ➔ **Select speed** ➔ 
- Frame subject on Display**  
 ➔ 
  - After shooting, index image or a composite image appears.
  - When shooting speed is set to **Manual** (4 Pictures and 9 Pictures modes), repeat  for each shot.











- (Long Press)**

- All captured photos are saved.

### Saving the Selected Photo

After ,  (select photo) ➔ 

### Adding Frames (Photo Camera)

- In mode menu, Add Frame**  
 ➔ 
  - Preset Frames** ➔ 
  - Select frame** ➔ 
  - Frame subject on Display**  
 ➔ 
    - Photo is captured.
    - Press  to save photo. (Viewfinder returns.)
- Using Frames in Data Folder  
 In , **Data Folder** ➔  ➔ **Select frame** ➔  ➔  ➔ **Frame subject on Display** ➔ 

## Area Setup

When activating TV for the first time, set up channels by area. (TV is exclusively for use in Japan.)

1



• Setup confirmation appears.

2 Yes



3 Select region

4 Select prefecture   
Select locality



• After setup, channel list appears.

5



• To watch TV, select **Digital TV** and press .

### Watching TV without Completing Area Setup

In , **No Preference**

#### Adding Reception Areas

**Set Channels**

**Change Area** **Select Area**

**Set Area Info** **From**

### TV Antenna

TV Antenna is located behind Display. Move handset to find best reception.

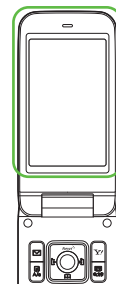

Antenna Area

## Watching TV

Complete Area setup (P.8-1) first.

1 



TV Window

2 Use Keypad to select channel

- Use  to surf channels in list order; Long Press to find channel with stable signal automatically.

3  Yes  TV ends

### Incoming Calls

- Press  to answer calls.

### Incoming Messages

- Tone sounds and notice appears. Long Press  to access messages.





### Changing Display Size/TV Orientation [TV Window]

- Press  to toggle view between Full Screen, Normal (Portrait), Enlarge (Portrait) and Normal (Landscape).
- In portrait view, Data Broadcast appears below TV image.

### Important Digital TV Usage Notes

- Do not use TV while driving or cycling. Accidents may result. Phone use while driving is prohibited by the Road Traffic Law (revised November 1, 2004). When walking, always pay attention to your surroundings, especially near road/rail crossings, etc.
- When using TV while charging Battery, separate AC Charger and Antenna to avoid interference.
- Call transmissions, incoming messages or mobile phone use in the immediate vicinity may affect audiovisual quality.
- Programs may not be viewable or record properly when:
  - Too far from or too close to broadcasting stations
  - In mountainous areas or near tall buildings
  - Aboard trains or in moving vehicles
  - Near high-voltage lines, neon lights or wireless base stations
  - Near railroad tracks or highways
  - Anywhere interfering signals are broadcast/reception is unstable

### Main Key Assignments

Open Options Menu	
Toggle Panel On/Off	 (in portrait view)  (in landscape view)
Volume Control	

<sup>1</sup>In portrait view, Volume Operation mode.

### Multi Selector

Multi Selector response changes with TV orientation.

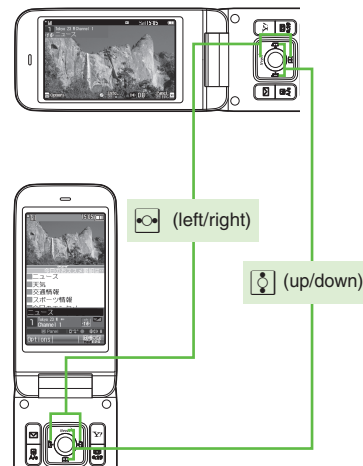

## Panel Description

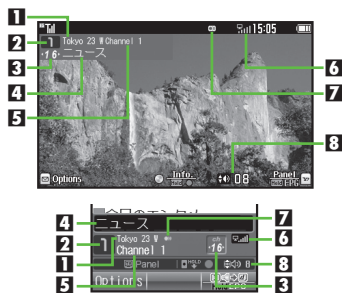

1	Area name	5	Station name
2	Channel key	6	Signal strength*
3	Channel	7	Sound Channel
4	Program name	8	Volume

\*More bars indicate stronger signal.  
Indicator position varies with Display content, etc.

## Data Broadcast (Japanese)

In portrait view, Data Broadcast appears below TV image. Use to select an item and press to access program-related information and interactive services. In Volume Operation mode, press to switch to Data Operation mode first.

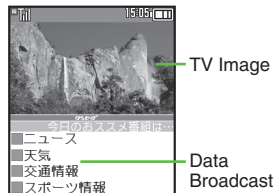

Data Broadcast Window

## Data Broadcast Fees

- Data Broadcast information viewing is free; however, using data links/related services incurs Internet connection fees.
- Confirmation appears the first time a fee-based Network connection is established from a channel; if accepted, further Network connections are established without confirmation until the channel is changed.

## Recording Programs

Record current program on Memory Card.

### Precautions

- Saved files cannot be forwarded or attached to messages.
- SoftBank 105SH encryption technology prevents unauthorized copying or playback of Memory Card files. Files copied from Memory Card to other cards on PC are unplayable.
- Copyright laws limit duplicated material to private use only, and prohibit unauthorized reproduction/other use.
- SoftBank Mobile is not liable for any damages resulting from accidental loss or alteration of recorded content.

- 1 In TV window,  (Long Press) ➔ Recording starts



Recording Window

- Changing Volume, etc. does not affect recordings.
- When Notification Lamp flashes orange, reception is poor; change location to where Notification Lamp illuminates green.

- 2  (Long Press) ➔ Recording ends

### Recording Programs in Portrait View

[TV Window]  (Long Press)

- To stop, Long Press  while recording.
- Memory/Battery Runs Low or Video Call is Accepted**
- Recording stops. (Recorded content is saved.)

## Playing Recorded Programs

- 1 In TV window,   $\rightarrow$  TV Player  $\rightarrow$  



Video List

- Files with  are unplayable.

- 2 Select file  $\rightarrow$  











Playback Window

- Playback starts. (The last played file plays from where it stopped.)

- 3  (Long Press)  $\rightarrow$  Playback stops

### Main Playback Operations

Adjust Volume or open Options menu following the same operations used while watching TV.

Fast Forward	 <sup>1</sup>
Rewind	 <sup>1, 2</sup>
Skip Forward	
Skip Backward	
Pause <sup>3</sup>	 <sup>4</sup>
Split File	 (Long Press)
Set Marker	
Toggle Panel On/Off	

<sup>1</sup> Each press increases speed. To resume normal playback, press .













<sup>2</sup> Long Press to replay. (Available when no Marker is saved.)

<sup>3</sup> In pause, use  to reverse/advance frame.

<sup>4</sup> In portrait view, Volume Operation mode.



## TV Timer & TV Recording Timer

- 1 In TV window,  ➔ **Rec.**  
**Operation** ➔ 
- 2 **Reservation List** ➔ 
- 3  ➔ **New Entry** ➔ 
- 4 **Manual** ➔  ➔ **Watching or Recording** ➔ 
- 5 **Enter start date/time** ➔   
➔ **Enter end date/time** ➔ 
- 6 **Channel:** ➔  ➔ **Select channel** ➔  ➔ 

### Setting Timer from EPG

In , **From TV Listing** ➔ 

- Refer to the application's help menu for operational instructions.

### Recording Timer Precautions

Confirm target channel reception; keep handset open.

- Insert a Memory Card.
- End all active functions/applications.
- Be sure Battery is charged adequately and there is enough free memory.

### At Timer Time (TV Alarm Time)

TV and Alarm activate.

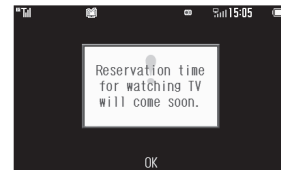

Signal reception starts slightly before the Timer start time and program recording/viewing ends a few seconds after the Timer end time.

### While Using Another Function

- TV activates (Multi Job) and target program recording/viewing starts. However, if Multi Job cannot activate in the current state, TV may remain off, or the current function may end automatically (unsaved images, messages, Phone Book entries, etc. may be deleted). End all active functions/applications before Timer time.

## Media Player Basics

Use Media Player to play music/video on handset.

- Download media files directly from Mobile Internet sites using Media Player.
- Transfer PC music files and save them on Memory Card.

### Music File Support

#### My Music

(Handset/Memory Card)  
Downloads/Transferred Files

### Video File Support

#### My Videos

(Handset/Memory Card)  
Downloads/Recorded Files

### Playback Precautions

- Media Player may not support some recording/playback formats. Files may not play depending on the Memory Card status.
- Playback stops for incoming calls.
- If Battery is low, Media Player will not play. Playback stops if Battery runs low during playback.
- Turn down Volume if distortion is noticeable in Speaker sound.
- Handset plays media while it downloads (progressive download). Packet transmission fees apply even while playback is paused.

### Compatibility

- Files transferred from PCs cannot be used as ringtones or System Sounds.

## Downloading Media Files

Download media files from the Internet. Read information (fee, expiry, etc.) on the source site.

1  **Media**  

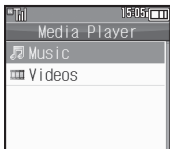

2 **Music or Videos**  

3 **Download Music or  
Download Videos**  

- Follow the links to download media.

## Saving Music Files from PCs

- Use software to convert music file format.
- For software usage and specifications, see the provider's website, etc.
- SoftBank Mobile does not guarantee compatibility with any software.
- USB Cable may be purchased separately.

### Handling Transferred Files

- Copyright laws limit duplicated material to private use only.
- Files created with PC software, etc. may not play.
- Comply with copyright and other intellectual property laws when using obtained files.

## Playing Music

1 → **Media** → → **Music**  
→

2 **My Music** → → **Select**  
**tab (folder)**



Music Playlists Window

3 **All Music** →

4 **Select file** →



Music Playback Window

- Album art appears for compatible Chaku-Uta Full® files.

### Using Other Functions while Playing Music

After , or

- To stop playback in Standby:  
 → **Yes** →

### Searching for Music Files

After , → **Search** → → Enter  
search text →

### Lyric Display-Compatible Files

- Press to display lyrics.

### Main Music Playback Operations

<b>Replay</b>	(Long Press: Rewind*, Double Press: Skip Backward)
<b>Skip Forward</b>	(Long Press: Fast Forward*)
<b>Volume Down</b>	(Long Press: Mute)
<b>Volume Up or Cancel Mute</b>	
<b>Pause</b>	
<b>Stop</b>	In Pause,
<b>Open Help</b>	

\*Release for playback.

### Music Playback Window Description



<b>1</b>	Title	<b>6</b>	Elapsed Time
<b>2</b>	Artist Name	<b>7</b>	Volume
<b>3</b>	Track Number	<b>8</b>	Information Link
<b>4</b>	Status	<b>9</b>	Sound Effects
<b>5</b>	Playback Mode		

## Playing Video

1

2 *My Videos*

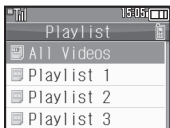

Video Playlists Window

3 *All Videos*

4 *Select file*

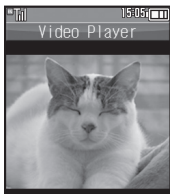

Video Playback Window

5 Playback stops

### Searching for Video Files

After *Search*

### At Alarm Time

- Playback pauses.

### Video Recorded on Other Devices

- Video may appear rotated.

### Main Video Playback Operations

For volume up/down, pause or help, see P.8-9 "Main Music Playback Operations."

<b>Replay</b>	(Long Press: Rewind', Double Press: Skip Backward)
<b>Skip Forward</b>	(Long Press in Pause: Advance Frame, Long Press: Fast Forward')
<b>Interface On/Off</b>	
<b>Toggle Display Size</b>	

'Release for playback.

### Video Playback Window Description



1	Title	6	Elapsed Time
2	Author Name	7	Volume
3	Clip Number	8	Information Link
4	Status	9	Sound Effects
5	Playback Mode		

## Using Playlists

Playlists store music/video in a playback order. Add favorite media files to Playlists, or organize files by artist/genre.

Playlists store only file locations. Source files remain in All Music or All Videos.

### Adding to Playlist

To add a music file to **プレイリスト1**:

- 1  ➔ **Media** ➔  ➔ **Music**  
➔
- 2 **My Music** ➔



Playlists Window

- 3 **All Music** ➔  ➔ **Select file**  
➔
- 4 **Add to Playlist** ➔  ➔ **プレイリスト1** ➔

### Renaming Playlists

- 1 In Playlists window, select Playlist ➔
- 2 **Edit List Title** ➔  ➔ **Enter name** ➔

## Customer Service

For information about SoftBank handsets or services, contact us at the following numbers.

### ■ SoftBank Customer Support

#### General Information

From a SoftBank handset, dial toll free at **157**  
 From a landline/IP phone, dial toll free at **0800-919-0157**

#### Customer Assistance (Repairs/Lost Handsets)

From a SoftBank handset, dial toll free at **113**  
 From a landline/IP phone, dial toll free at **0800-919-0113**

If you cannot reach a toll free number, use the number (charges apply) below for your service area:

Hokkaido Area Tohoku Area Hokuriku Area Kanto-Koshinetsu Area	022-380-4380	Tokai Area	052-388-2002
Kansai Area	06-7669-0180	Chugoku-Shikoku Area Kyushu-Okinawa Area	092-687-0010

### ■ SoftBank Mobile Global Call Center

From outside Japan, dial **+81-3-5351-3491** (toll free from SoftBank handsets)  
 If handset is lost/stolen, call this number immediately (international charges apply)

### ■ SoftBank Mobile Website

<http://mb.softbank.jp/en/>

## Software Update

Check for firmware updates and download as required.

### Precautions

- Handset is disabled until update is complete. Update may take up to approximately 30 minutes.
- Update failure may disable handset. To reduce failure risk, make sure signal is strong and stable, and charge Battery adequately beforehand.
- Update will not start if another function is in use. Before updating software (or before scheduled update time), end all active functions/applications.
- Disconnect USB Cable beforehand to reduce failure risk.
- Always back up important information. SoftBank Mobile cannot be held liable for damages from lost information, etc.

### Updating Software

Packet transmission fees do not apply to updates (including checking, downloading and overwriting).

1   **Settings**    
**Phone/Software Update** 

2 **Software Update** 

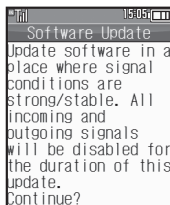

3   
 • Follow onscreen instructions.

### Update Result

In 2, **Update Result** 

### Scheduled Update (Japanese)

SoftBank Mobile sends update notice to handset; read and change preset update schedule as needed. Confirmation appears at scheduled update time. Press  or wait a while for update to start.

### When Updated

Update success notification appears and handset reboots.

After reboot, completion message appears and Information window opens.

### Update Result

**While Information window appears,**  
**Update Result** 

### Reboot Failure

- If handset does not reboot after update, reinsert Battery and try powering on. If it still does not power on, contact SoftBank Customer Support, Customer Assistance (P.9-1).



## Safety Precautions







Read Safety Precautions before using handset.

- Observe precautions to avoid injury to self or others, or damage to property.
- SoftBank Mobile is not liable for any damages resulting from use of this product.

**These labels show degree of risk from improper use;  
learn them before reading on:**

 <b>DANGER</b>	<b>Great risk of death or serious injury</b>
 <b>WARNING</b>	<b>Risk of death or serious injury</b>
 <b>CAUTION</b>	<b>Risk of minor injury or damage to property</b>

**These symbols signify prohibited/compulsory actions;  
learn them before reading on:**

 Prohibited	<b>Prohibited actions</b>
 Do Not Disassemble	<b>Disassembly prohibited</b>
 Avoid Liquids Or Moisture	<b>Exposure to liquids prohibited</b>
 Do Not Use Wet Hands	<b>Use with wet hands prohibited</b>
 Compulsory	<b>Compulsory actions</b>
 Disconnect Power Source	<b>Unplug from outlet</b>

**Handset, Battery, USIM Card,  
Charger (Sold Separately) &  
Memory Card (Sold Separately)**

 **DANGER**

**Use specified Battery and Charger only.**

Non-specified equipment use may cause Battery to leak, overheat, burst or ignite, and may cause Charger to overheat, ignite, malfunction, etc.



Compulsory

**Do not disassemble, modify or solder handset or related hardware.**

May cause fire, injury, electric shock or malfunction. Battery may leak, overheat, burst or ignite.

Modifying handsets is prohibited by the Radio Law and subject to a penalty.



Do Not Disassemble

**Do not expose handset or related hardware to liquids.**

Do not let exposed handset/related hardware remain wet; do not charge wet Battery. May cause overheating, electric shock, fire, injury or malfunction. Use only as directed.



Avoid Liquids Or Moisture

Do not charge Battery in or expose handset or related hardware to extreme heat (fire, heat sources, direct sunlight, inside vehicles, etc.).



Prohibited

Do not charge, leave, use, or be carrying handset or related hardware in a warm place or where heat collects, such as under a kotatsu (blanketed warming table) or electric blanket, next to a kairo (worn warming patch), etc.

May cause warping/malfunction; Battery may leak, overheat, ignite or burst. Handset or related hardware may become hot to the touch, leading to burn injuries, etc.

**Do not force Battery/Charger into handset. Confirm terminal/connector orientation; retry.**

Battery may leak, overheat, burst, ignite, etc.



Prohibited

 **WARNING**

**Do not place handset, Battery or Charger in/on ovens, microwave ovens, pressure cookers, induction stoves or other cooking appliances.**

Battery may leak, overheat, burst or ignite. Handset/Charger may overheat, emit smoke, ignite, malfunction, etc.



Prohibited

**Keep handset off and Charger disconnected near gas stations or places with fire/explosion risk.**

Handset use near petrochemicals or other flammables may cause fire/explosion.



Compulsory

**Do not drop/throw or apply strong impacts.**

Battery may leak, overheat, burst or ignite, resulting in fire, electric shock, malfunction, etc.



Prohibited

**For unusual sound/odor, smoke or other abnormality:**

Continued use may cause fire, electric shock, etc.: grasp plug to disconnect Charger, power off, then remove Battery, being careful not to burn or injure yourself.



Compulsory

**Keep liquid (water, pet urine, etc.) or conductive material (pencil lead, metal strip/jewelry, etc.) away from External Device Port.**

May cause short circuit, resulting in fire, malfunction, etc.



Prohibited

## CAUTION

### Do not place handset or related hardware on unstable surfaces.

Handset or related hardware may fall, resulting in injury, malfunction, etc.; take added care when Vibration is set or while charging.



Prohibited

### Keep handset and related hardware out of infants' reach.

Infants may choke from swallowing handset or related hardware or be injured, etc.



Compulsory

### For use of handset/related hardware by child, explain instructions and supervise use.

Misuse may cause injury, etc.



Compulsory

## Battery

## DANGER

Read battery label to confirm battery type; use/dispose of Battery accordingly.

Symbol on Label	Battery Type
Li-ion00	Lithium-ion

### Do not dispose of Battery in fire.

Battery may leak, burst, ignite, etc.



Prohibited

Do not damage (nail, hammer, stomp, etc.) Battery or subject it to strong impacts.

Battery may leak, overheat, burst, ignite, etc.



Prohibited

Keep wire or other metal objects away from battery terminals. Do not carry/store Battery with conductive material (pencil lead, metal strip/jewelry, etc.).

Battery may leak, overheat, burst, ignite, etc.



Prohibited

If battery fluid gets in eyes, do not rub; rinse with water and consult a doctor immediately.

Eyes may be severely damaged.



Compulsory

## WARNING

If battery fluid contacts skin or clothes, discontinue handset use and rinse with clean water immediately.

May cause skin damage.



Compulsory

If Battery does not charge properly, stop trying.

Battery may leak, overheat, burst, ignite, etc.



Compulsory

For abnormal odor, excessive heat, discoloration or distortion, remove Battery, being careful not to burn or injure yourself. Avoid fire sources.

Continued use may cause Battery to leak, overheat, burst, ignite, etc.



Compulsory

Keep Battery away from pets.

Pet bites may cause Battery to leak, burst, overheat, ignite, etc.



Compulsory

## CAUTION

Do not dispose of an exhausted Battery with ordinary refuse.

Tape over battery terminals before disposal. Take Battery to a SoftBank Shop, or follow the local disposal regulations.



Prohibited

For any skin irritation associated with use, discontinue use and consult a doctor.

Metal and other materials may cause skin irritation, rashes, or itchiness depending on your physical condition.



Compulsory

**Handset**



**WARNING**

**Do not use handset while driving or cycling.**

Accidents may result. Phone use while driving or cycling is prohibited by law and subject to a penalty; park legally beforehand.



Prohibited

**Power off near electronic devices that employ high precision control systems or weak signals.**

May cause electronic malfunctions, etc. Take added care near these devices: Hearing aids, implanted pacemakers/defibrillators and other electronic medical equipment; fire alarms, automatic doors and other automatic control devices.



Compulsory

**Power off before boarding aircraft to avoid possible radio wave interference with aircraft operations.**

If mobile phone use is allowed on board, follow airline or cabin crew instructions regarding handset use.



Compulsory

**Users with a heart condition should adjust ringtone Vibration and Volume as needed.**

May cause heart damage.



Compulsory

**If thunder is audible while outdoors, power off; find cover.**

There is a risk of lightning strike or electric shock.



Compulsory

**Do not look into Infrared Port during Infrared transmissions.**

Eyesight may be affected.



Prohibited



**CAUTION**

**Do not use handset when it may affect a vehicle's electronic equipment.**

Handset use inside vehicles may cause electronic equipment to malfunction, resulting in accidents.



Prohibited

**For any skin irritation associated with use, discontinue use and consult a doctor.**

Metal and other materials may cause skin irritation, rashes, or itchiness depending on your physical condition.



Compulsory

**Keep handset away from magnetic cards, etc.**

Data on bank cards, credit cards, telephone cards, floppy disks, etc. may be lost.



Prohibited

**Do not swing handset by Strap.**

May harm self or others; Strap may break, resulting in injury or handset malfunction/breakage.



Prohibited

**Handset may become hot while in use, especially at high temperature.**

Prolonged contact with skin may cause burn injuries.



Compulsory

**Always maintain some distance from Speaker while ringtones, music or other handset sounds play.**

Excessive volume may damage ears or hearing.



Prohibited

**Keep fingers, Straps, etc. outside when opening/closing handset.**

May cause injury, breakage, etc.



Compulsory

**Watch TV from a distance in good light.**

Watching in poor light or too close may affect eyesight.



Compulsory

**Moderate handset Volume when using Headphones.**

Excessive volume may damage ears or hearing.



Compulsory

## Charger (Sold Separately)

 **WARNING****Do not cover/wrap Charger while charging.**

Charger may overheat, resulting in fire, malfunction, etc.



Prohibited

**Use only the specified voltage.**

Non-specified voltages may cause fire, malfunction, etc.

- AC Charger: AC 100 V-240 V Input
- In-Car Charger (use in negative earth vehicles only): DC 12 V/24 V Input

Do not use power adapters.

Transformer use may cause fire, electric shock or malfunction.



Prohibited

**Unplug Charger for periods of disuse; grasp plug to disconnect.**

May cause electric shock, fire or malfunction.

Disconnect  
Power Source**Use only the specified fuse for In-Car Charger.**

Non-specified fuse may cause fire or malfunction. See In-Car Charger manual for details.



Compulsory

If liquid (water, pet urine, etc.) gets inside, grasp plug to disconnect it immediately.

May cause electric shock, smoke or fire.

Disconnect  
Power Source

To remove debris, grasp plug to disconnect Charger, then clean with dry cloth.

Fire may result.



Compulsory

Do not use In-Car Charger in positive earth vehicles.

May cause fire, etc. Use in negative earth vehicles only.



Prohibited

Plug Charger firmly into the outlet, keeping plug and terminals away from conductive material (pencil lead, metal strip/jewelry, etc.).

May cause electric shock, short circuit, fire, etc.



Compulsory

Do not touch plug with wet hands.

May cause electric shock, malfunction, etc.

Do Not Use  
Wet Hands

Do not touch Charger if thunder is audible.

May cause electric shock, etc.



Prohibited

 **CAUTION**

Grasp plug to disconnect Charger before cleaning.

May cause electric shock, etc.

Disconnect  
Power Source

Always grasp plug (not cord) to disconnect Charger.

Pulling plug by cord may damage cord; may cause electric shock, fire, etc.



Compulsory

Do not subject AC Charger to strong impacts while it is plugged in.

May cause malfunction or injury.



Prohibited

## Handset Use & Electronic Medical Equipment

This section is based on "**Guidelines on the Use of Radio Communications Equipment such as Cellular Telephones and Safeguards for Electronic Medical Equipment**"

(Electromagnetic Compatibility Conference, April 1997) and "**Report of Investigation of the Effects of Radio Waves on Medical Equipment, etc.**" (Association of Radio Industries and Businesses, March 2001).



## WARNING

**Persons with implanted pacemaker/defibrillator should keep handset more than 22 cm away.**

Radio waves may interfere with implanted pacemakers or defibrillators.



Compulsory

**If you intend to use electronic medical equipment other than implanted pacemaker/defibrillator outside medical facilities, consult the vendor on radio wave effects.**

Radio waves may interfere with electronic medical equipment.



Compulsory

**Observe these rules inside medical facilities to avoid effects of radio waves on electronic medical equipment:**



Compulsory

- Do not enter an operating room or an Intensive or Coronary Care Unit while carrying a handset.
- Keep handset off in hospitals.
- Even in lobbies or other places where handset use is permitted, keep handset off near electronic medical equipment.
- Obey medical facility rules on mobile phone use.

**Power off in crowds or trains where persons with implanted pacemaker/defibrillator may be near.**



Compulsory

Radio waves may interfere with implanted pacemakers or defibrillators causing such devices to malfunction.

## General Notes

### General Use

- SoftBank Mobile is not liable for any damages resulting from accidental loss/alteration of handset/Memory Card files or settings. Keep separate copies of contacts, etc.
- Handset transmissions/TV signal reception may be disrupted inside buildings, tunnels or underground, or when moving into/out of such places.
- Use handset without disturbing others.
- Handsets are radios as stipulated by the Radio Law. Under the Radio Law, handsets must be submitted for inspection upon request.
- Handset use near landlines, TVs or radios may cause interference.
- For proper use of Memory Card, read the manual beforehand.
- **Beware of eavesdropping.**  
Because this service is completely digital, the possibility of signal interception is greatly reduced. However, some transmissions may be overheard.
- **Eavesdropping**  
Deliberate/accidental interception of communications constitutes eavesdropping.
- Beware of harmful/malicious websites. Take added care when posting personal information, etc.
- An export license may be required to carry handset into other countries if it is to be used by or transferred to another person. However, no such license is required when you take handset abroad for personal use on a vacation or business trip and then bring it back.  
Export control regulations in the United States provide that an export license granted by the US government is required to carry handset into Cuba, Iran, North Korea, Sudan or Syria.

### Handset & Hardware Care

- Handset is not water proof. Avoid moisture.
  - Keep handset away from precipitation.
  - Cold air from air conditioning, etc. may condense causing corrosion.
  - Avoid leaving handset in damp places (restroom, bath/shower, etc.).
  - On the beach, keep handset away from water and direct sunlight.
  - Perspiration may get inside handset causing malfunction.
- If handset is left with no Battery inserted or an exhausted one, data may be altered/lost. SoftBank Mobile is not liable for any resulting damages.
- Use handset within 5°C - 35°C and 35% - 85% humidity.
- Avoid extreme temperature or direct sunlight.
- Handset/Battery may become warm during operation or while charging. This is normal.
- Warranty does not cover malfunctions resulting from misuse.
- Exposing Lens to direct sunlight may damage Color Filter and affect image color.
- Battery may not charge properly if Port/terminals are obstructed by dust, etc. Clean with dry cloth, cotton swab, etc.
- Clean handset with soft dry cloth. Alcohol/solvent use may fade color/print.
- Avoid scratching Display.
- Avoid heavy objects or excessive pressure. May cause malfunction or injury.
  - Do not sit on handset in back pants pocket.
  - Do not place heavy objects on handset inside handbags, packs, etc.
- Connect only specified products to External Device Port. Other devices may malfunction or cause damage.
- Always power off before removing Battery. If Battery is removed while saving data or sending mail, data may be lost, changed or destroyed.
- Do not power off while using Memory Card; may result in data loss or malfunction.
- When walking outside, moderate handset Volume to avoid accidents.
- Avoid covering Speaker while using handset.

### Function Usage Requirement

USIM Card must be inserted to use handset.

### Camera

- Mind etiquette when using Camera.
- Test Camera before capturing/recording special moments.
- Do not use Camera in places where shooting is prohibited.
- Captured images may not be used/transferred without copyright holder (photographer, etc.) permission, except for personal use.

### In-Call/Transmission Caution

During calls/transmissions, calling/transmission charges/fees apply even if other functions or operations are simultaneously in use.

### Portrait Rights

Portrait rights protect individuals' right to refuse to be photographed or to refuse unauthorized publication/use of their photographs. Portrait rights consist of the right to privacy, which is applicable to all persons, and the right to publicity, which protects the interests of celebrities. Therefore, photographing others including celebrities and publicizing/distributing their photographs without permission is illegal; use Camera responsibly.

### Copyrights

Copyright laws protect sounds, images, computer programs, databases, other materials and copyright holders. Duplicated material is limited to private use only. Use of materials beyond this limit or without copyright holder permission may constitute copyright infringement, and be subject to criminal punishment. Comply with copyright laws when using images captured with Camera.

The software contained in handset is copyrighted material; copyright, moral right and other related rights are protected by copyright laws. Do not copy, modify, alter, disassemble, decompile or reverse-engineer the software; do not separate it from hardware in whole or part.

### Electromagnetic Safety

For body-worn operation, this phone has been tested and meets RF exposure guidelines when used with accessories containing no metal, that position handset a minimum of 15 mm from the body. Use of other accessories may not ensure compliance with RF exposure guidelines.

### CE Declaration of Conformity

# CE 0168

Hereby, Sharp Telecommunications of Europe Ltd, declares that 10SSH is in compliance with the essential requirements and other relevant provisions of Directive 1999/5/EC. A copy of the original declaration of conformity for each model can be found at the following Internet address: <http://www.sharp.co.jp/k-tai/>

### Battery Cautions

#### Use specified Battery or Charger only.

Non-specified equipment use may cause malfunctions, electric shock or fire due to battery leakage, overheating or bursting.

Do not dispose of an exhausted Battery with ordinary refuse; always tape over battery terminals before disposal. Take Battery to a SoftBank Shop, or follow the local disposal regulations.

Charge Battery in ambient temperature 5°C - 35°C; Battery may leak/overheat and performance may deteriorate outside this range.



## European RF Exposure Information

Your mobile device is a radio transmitter and receiver. It is designed not to exceed the limits for exposure to radio waves recommended by international guidelines. These guidelines were developed by the independent scientific organization ICNIRP and include safety margins designed to assure the protection of all persons, regardless of age and health.

The guidelines use a unit of measurement known as the Specific Absorption Rate, or SAR. The SAR limit for mobile devices is 2 W/kg.

As mobile devices offer a range of functions, they can be used in other positions, such as on the body as described in this user guide<sup>1</sup>.

Highest SAR value:

Model	At the Ear <sup>2</sup>	On the Body
105SH	0.789 W/kg	0.980 W/kg

As SAR is measured utilizing the device's highest transmitting power the actual SAR of this device while operating is typically below that indicated above. This is due to automatic changes to the power level of the device to ensure it only uses the minimum level required to reach the Network.

The World Health Organization has stated that present scientific information does not indicate the need for any special precautions for the use of mobile devices. They note that if you want to reduce your exposure then you can do so by limiting the length of calls or using a handsfree device to keep the mobile phone away from the head and body.

<sup>1</sup>Please see Electromagnetic Safety on **P.10-8** for important notes regarding body-worn operation.

<sup>2</sup>Measured in accordance with international guidelines for testing.

## Headphone Signal Level

The maximum output voltage for the music player function, measured in accordance with EN 50332-2, is 27.0 mV.

### FCC Notice

- This device complies with part 15 of the FCC Rules. Operation is subject to the following two conditions:  
(1) This device may not cause harmful interference, and (2) this device must accept any interference received, including interference that may cause undesired operation.
- Changes or modifications not expressly approved by the manufacturer responsible for compliance could void the user's authority to operate the equipment.

## FCC Information to User

This equipment has been tested and found to comply with the limits of a Class B digital device, pursuant to Part 15 of the FCC Rules. These limits are designed to provide reasonable protection against harmful interference in a residential installation. This equipment generates, uses and can radiate radio frequency energy and, if not installed and used in accordance with the instructions, may cause harmful interference to radio communications.

However, there is no guarantee that interference will not occur in a particular installation; if this equipment does cause harmful interference to radio or television reception, which can be determined by turning the equipment off and on, the user is encouraged to try to correct the interference by one or more of the following measures:

1. Reorient/relocate the receiving antenna.
2. Increase the separation between the equipment and receiver.
3. Connect the equipment into an outlet on a circuit different from that to which the receiver is connected.
4. Consult the dealer or an experienced radio/TV technician for help.

**FCC RF Exposure Information**

Your handset is a radio transmitter and receiver. It is designed and manufactured not to exceed the emission limits for exposure to radio frequency (RF) energy set by the Federal Communications Commission of the U.S. Government.

The guidelines are based on standards that were developed by independent scientific organizations through periodic and thorough evaluation of scientific studies. The standards include a substantial safety margin designed to assure the safety of all persons, regardless of age and health. The exposure standard for wireless handsets employs a unit of measurement known as the Specific Absorption Rate, or SAR. The SAR limit set by the FCC is 1.6 W/kg.

Highest SAR value:

Model	FCC ID	At the Ear	On the Body
105SH	APYHRO00166	0.358 W/kg	0.496 W/kg

This device was tested for typical body-worn operations with the back of the handset kept 15 mm from the body. To maintain compliance with FCC RF exposure requirements, use accessories that maintain a 15 mm separation distance between the user's body and the back of the handset. The use of beltclips, holsters and similar accessories should not contain metallic components in its assembly.

The use of accessories that do not satisfy these requirements may not comply with FCC RF exposure requirements, and should be avoided. The FCC has granted an Equipment Authorization for this model handset with all reported SAR levels evaluated as in compliance with the FCC RF emission guidelines. SAR information on this model handset is on file with the FCC and can be found at <http://www.fcc.gov/oet/ea> under the Display Grant section after searching the corresponding FCC ID (see preceding table). Additional information on Specific Absorption Rates (SAR) can be found on the Cellular Telecommunications & Internet Association (CTIA) Website at <http://www.phonefacts.net>.

## Specific Absorption Rate (SAR)

### **SoftBank 105SH meets the government's requirements for exposure to radio waves.**

These requirements are based on scientific basis to assure that radio waves emitted from mobile phones and other handheld wireless devices do not affect human health. They require that the Specific Absorption Rate (SAR), which is the unit of measurement for the amount of radiofrequency absorbed by the body, shall not exceed 2 W/kg<sup>\*</sup>. This limit includes a substantial safety margin designed to assure the safety of all persons, regardless of age or health, and meets the international standard set by International Commission on Non-Ionizing Radiation Protection (ICNIRP) in cooperation with World Health Organization (WHO).

The highest SAR value of SoftBank 105SH is 0.700 W/kg. SAR tests were conducted with handset transmitting at its highest certified power level in accordance with testing methods set by the government. While there may be differences between the SAR levels for various handsets, they all meet the governmental requirements for safe exposure. The actual SAR level of the handset while operating can be well below the highest value. This is because the handset is designed to operate at multiple power levels so as to use only the power required to reach the Network. Additional information on SAR can be obtained on the following Websites.

Ministry of Internal Affairs and Communications (MIC)  
<http://www.tele.soumu.go.jp/e/sys/ele/body/index.htm>  
Association of Radio Industries and Businesses (ARIB)  
<http://www.arib-erm.org/> (Japanese)

<sup>\*</sup>Requirements are stipulated in Radio Law (Ordinance Regulating Radio Equipment, Article 14-2).